



SAN FRANCISCO PLANNING DEPARTMENT

Executive Summary Conditional Use

HEARING DATE: DECEMBER 19, 2013

Date: December 12, 2013
Case No.: **2009.1177ECV**
Project Address: **2353 LOMBARD STREET**
Zoning: NC-3 (Neighborhood Commercial, Moderate Scale)
40-X Height and Bulk District
Block/Lot: 0512/025 and 026
Project Sponsor: Gary Gee
98 Brady Street,
San Francisco, CA 94103
Staff Contact: Sharon Lai – (415) 575-9087
sharon.w.lai@sfgov.org
Recommendation: **Approval with Conditions**

1650 Mission St.
Suite 400
San Francisco,
CA 94103-2479

Reception:
415.558.6378

Fax:
415.558.6409

Planning
Information:
415.558.6377

PROJECT DESCRIPTION

The proposal is to demolish the existing one-story vacant commercial building that was last occupied by a restaurant, and construct with a four-story mixed-use building. The project proposes to merge the two lots resulting in a lot containing approximately 12,850 square feet of lot area and approximately 131 feet of lot frontage. The proposal will maintain the existing vehicular easement from the rear abutting property to Lombard Street by providing a garage door along the rear property line.

The proposed 40 foot tall building comprises three stories of residential units over ground floor commercial space and residential parking. Project features include 21 dwelling units, two commercial spaces, 2,516 square feet of common usable open space on the roof deck, 4,552 square feet of private usable open space, 28 residential parking spaces, and 22 Class 1 bicycle storage spaces. The proposed unit mix includes three one-bedroom units of approximately 703 square feet, and 18 two-bedroom units ranging from 1,138 to 1,264 square feet. The sponsor has elected to pay an in-lieu fee to comply with Planning Code Section 415, the Inclusionary Affordable Housing Fee.

SITE DESCRIPTION AND PRESENT USE

The project site is located on the south side of Lombard Street between Pierce and Scott Streets, Lots 025 and 026 in Assessor's Block 0512 within the Marina neighborhood. The site is located in an NC-3 (Neighborhood Commercial, Moderate-Scale) and a 40-X Height and Bulk district. The project site contains two lots, the eastern lot (026) is an irregularly shaped lot approximately 73 feet wide at the widest point by 106 feet deep, and the western lot (025) is approximately 58 feet wide by 106 feet deep. The total lot area is approximately 12,850 square feet. The project site currently contains a one-story building that overlaps both lots, and was constructed in 1973. The building currently contains a single vacant commercial space that was last used as a restaurant. The area surrounding the commercial

building is used as a 30-car parking lot. The abutting rear lot (009) with frontage on Greenwich Street contains existing legal non-conforming open parking in the rear yard, and has an easement through lot 026 for vehicular access onto Lombard Street.

SURROUNDING PROPERTIES AND NEIGHBORHOOD

The subject block is zoned NC-3 along Lombard Street and the remaining lots are zoned RH-2 and RM-2. The project site is located adjacent to a vacant corner lot (southwest corner of Lombard and Pierce Streets) that was last occupied by a Chevron gas station to the east, and a four-story motel to the west. The remaining lot on the block-face (southeast corner of Lombard and Scott Streets) contains a four-story, 12-unit mixed-use building with ground floor commercial space and off-street parking, that was constructed in 2010. The block-face across Lombard Street is characterized by a mix of one-, two- and three-story tall buildings, with a pattern of ground floor commercial uses.

The subject NC-3 zoning district is a linear commercial corridor along Lombard Street (US Highway 101) between Van Ness Avenue and Baker Street, which is a heavily trafficked thoroughfare and major connector to and from the Golden Gate Bridge. This NCD offers a wide variety of goods and services to a population greater than the immediate neighborhood, including motels, eating and drinking establishments, auto related uses and other retail stores. Housing development in new buildings is encouraged above the first story in the subject zoning district.

ENVIRONMENTAL REVIEW

On June 23, 2010 the Project was determined to be exempt from the California Environmental Quality Act ("CEQA") as a Class 32 Categorical Exemption under CEQA as described in the determination contained in the Planning Department files for Case No. 2009.1177E.

HEARING NOTIFICATION

TYPE	REQUIRED PERIOD	REQUIRED NOTICE DATE	ACTUAL NOTICE DATE	ACTUAL PERIOD
Classified News Ad	20 days	November 27, 2013	November 27, 2013	22 days
Posted Notice	20 days	November 27, 2013	November 27, 2013	22 days
Mailed Notice	20 days	November 27, 2013	November 27, 2013	22 days

The proposal requires a Section 312-neighborhood notification, which was conducted in conjunction with the conditional use authorization process.

PUBLIC COMMENT

- The Department has not received any public comment to date.

ISSUES AND OTHER CONSIDERATIONS

- The project proposes to merge two lots and the proposed lot size is approximately 12,850 square feet, which exceeds the lot size limit for the subject district and thus required Conditional Use authorization.
- A portion of the proposed building will require a rear yard modification, considered under Case No. 2009.1177V.
- 28 off-street parking spaces are proposed for residential use, seven of which are permitted accessory parking spaces.
- Two commercial spaces are proposed to be constructed. The smaller commercial space, approximately 190 square feet in size, is intended for the property owner's use as a real estate management office. The larger commercial space will be 2,525 square feet with no proposed tenants at this time.

REQUIRED COMMISSION ACTION

In order for the project to proceed, the Commission must grant Conditional Use authorization to allow the lot merger resulting in a lot size in excess of 10,000 square feet within the NC-3 Zoning District, pursuant to Planning Code Sections 121 and 303.

BASIS FOR RECOMMENDATION

- The project will add 21 new dwelling units to the City's housing stock, 18 of which are family sized-units.
- The new commercial space will provide additional economic stimulus and employment opportunity to the neighborhood.
- The project is designed to be compatible with the scale and massing of the subject Lombard Street NC-3 Zoning District.
- New off-street parking and additional on-street parking will be created through the reduction of the existing curb cut.
- The Project will replace the existing under-utilized vacant commercial building and parking lot with a mixed-use building.
- The project is desirable for, and compatible with the surrounding neighborhood.

RECOMMENDATION: Approval with Conditions
--

Attachments:

Block Book Map
Sanborn Map
Zoning Map
Aerial Photographs
Site Photo
Reduced Plans
Renderings
Affordable Housing Affidavit

Attachment Checklist

- | | |
|---|---|
| <input checked="" type="checkbox"/> Executive Summary | <input checked="" type="checkbox"/> Project sponsor submittal |
| <input checked="" type="checkbox"/> Draft Motion | Drawings: <u>Existing Conditions</u> |
| <input type="checkbox"/> Environmental Determination | <input checked="" type="checkbox"/> Check for legibility |
| <input checked="" type="checkbox"/> Zoning District Map | Drawings: <u>Proposed Project</u> |
| <input type="checkbox"/> Height & Bulk Map | <input checked="" type="checkbox"/> Check for legibility |
| <input type="checkbox"/> Parcel Map | 3-D Renderings (new construction or significant addition) |
| <input checked="" type="checkbox"/> Sanborn Map | <input checked="" type="checkbox"/> Check for legibility |
| <input checked="" type="checkbox"/> Context Photos | <input type="checkbox"/> Wireless Telecommunications Materials |
| <input checked="" type="checkbox"/> Site Photos | <input type="checkbox"/> Health Dept. review of RF levels |
| | <input type="checkbox"/> RF Report |
| | <input type="checkbox"/> Community Meeting Notice |
| | <input checked="" type="checkbox"/> Housing Documents |
| | <input checked="" type="checkbox"/> Inclusionary Affordable Housing Program: Affidavit for Compliance |
| | <input type="checkbox"/> Residential Pipeline |

Exhibits above marked with an "X" are included in this packet

SL

Planner's Initials

SL: G:\DOCUMENTS\ICU\2353 Lombard St\2009\2009.1177C\2353 Lombard St - Executive Summary.doc



SAN FRANCISCO PLANNING DEPARTMENT

Subject to: (Select only if applicable)

- | | |
|--|--|
| <input type="checkbox"/> Affordable Housing (Sec. 415) | <input type="checkbox"/> First Source Hiring (Admin. Code) |
| <input type="checkbox"/> Jobs Housing Linkage Program (Sec. 413) | <input type="checkbox"/> Child Care Requirement (Sec. 414) |
| <input type="checkbox"/> Downtown Park Fee (Sec. 412) | <input type="checkbox"/> Other |

1650 Mission St.
Suite 400
San Francisco,
CA 94103-2479

Reception:
415.558.6378

Fax:
415.558.6409

Planning
Information:
415.558.6377

Planning Commission Draft Motion

HEARING DATE: DECEMBER 19, 2013

Date: December 12, 2013
Case No.: **2009.1177ECV**
Project Address: **2353 LOMBARD STREET**
Zoning: NC-3 (Neighborhood Commercial, Moderate Scale)
40-X Height and Bulk District
Block/Lot: 0512/025 and 026
Project Sponsor: Gary Gee
98 Brady Street,
San Francisco, CA 94103
Staff Contact: Sharon Lai – (415) 575-9087
sharon.w.lai@sfgov.org

ADOPTING FINDINGS RELATING TO THE APPROVAL OF CONDITIONAL USE AUTHORIZATION PURSUANT TO SECTIONS 121 AND 303 OF THE PLANNING CODE TO ALLOW THE DEMOLITION OF A VACANT ONE-STORY COMMERCIAL BUILDING AND CONSTRUCTION OF A FOUR-STORY MIXED-USE BUILDING CONTAINING 21 DWELLING UNITS, APPROXIMATELY 2,700 SQUARE FEET OF COMMERCIAL SPACE AND 28 RESIDENTIAL PARKING SPACES. THIS PROJECT WILL MERGE TWO LOTS RESULTING IN A LOT SIZE IN EXCESS OF 10,000 SQUARE FEET, WITHIN THE NC-3 (MODERATE-SCALE, NEIGHBORHOOD COMMERCIAL) DISTRICT AND A 40-X HEIGHT AND BULK DISTRICT. THE PROJECT REQUIRES A REAR YARD MODIFICATION PURSUANT TO PLANNING CODE SECTION 135 (CASE NO. 2009.1177V).

PREAMBLE

On January 15, 2013, Gary Gee (hereinafter "Project Sponsor") filed an application with the Planning Department (hereinafter "Department") for Conditional Use Authorization under Planning Code Sections 121 and 303 to allow the demolition of a vacant one-story commercial building and construction of a four-story mixed-use building containing 21 dwelling units, approximately 2,700 square feet of commercial space and 28 residential parking spaces. This project will merge two lots resulting in a lot size in excess of 10,000 square feet, within the NC-3 (Moderate-Scale, Neighborhood Commercial) District and a 40-X

Height and Bulk District. The project requires a rear yard modification pursuant to Planning Code Section 135 (Case No. 20009.1177V).

On December 19, 2013, the San Francisco Planning Commission (hereinafter "Commission") conducted a duly noticed public hearing at a regularly scheduled meeting on Conditional Use Application No. 2009.1177CV.

On June 23, 2010 the Project was determined to be exempt from the California Environmental Quality Act ("CEQA") as a Class 32 Categorical Exemption under CEQA as described in the determination contained in the Planning Department files for Case No. 2009.1177E.

The Commission has heard and considered the testimony presented to it at the public hearing and has further considered written materials and oral testimony presented on behalf of the applicant, Department staff, and other interested parties.

MOVED, that the Commission hereby authorizes the Conditional Use requested in Application No. 2009.1177CV, subject to the conditions contained in "EXHIBIT A" of this motion, based on the following findings:

FINDINGS

Having reviewed the materials identified in the preamble above, and having heard all testimony and arguments, this Commission finds, concludes, and determines as follows:

1. The above recitals are accurate and constitute findings of this Commission.
2. **Site Description and Present Use.** The project site is located on the south side of Lombard Street between Pierce and Scott Streets, Lots 025 and 026 in Assessor's Block 0512 within the Marina neighborhood. The site is located in an NC-3 (Neighborhood Commercial, Moderate-Scale) and a 40-X Height and Bulk district. The project site contains two lots, the eastern lot (026) is an irregularly shaped lot approximately 73 feet wide at the widest point by 106 feet deep, and the western lot (025) is approximately 58 feet wide by 106 feet deep. The total lot area is approximately 12,850 square feet. The project site currently contains a one-story building that overlaps both lots, and was constructed in 1973. The building currently contains a single vacant commercial space that was last used as a restaurant. The area surrounding the commercial building is used as a 30-car parking lot. The abutting rear lot (009) with frontage on Greenwich Street contains existing legal non-conforming open parking in the rear yard, and has an easement through lot 026 for vehicular access onto Lombard Street.
3. **Surrounding Properties and Neighborhood.** The subject block is zoned NC-3 along Lombard Street and the remaining lots are zoned RH-2 and RM-2. The project site is located adjacent to a vacant corner lot (southwest corner of Lombard and Pierce Streets) that was last occupied by a Chevron gas station to the east, and a four-story motel to the west. The remaining lot on the block-face (southeast corner of Lombard and Scott Streets) contains a four-story, 12-unit mixed-use building with ground floor commercial space and off-street parking, that was constructed in

2010. The block-face across Lombard Street is characterized by a mix of one-, two- and three-story tall buildings, with a pattern of ground floor commercial uses.

The subject NC-3 zoning district is a linear commercial corridor along Lombard Street (US Highway 101) between Van Ness Avenue and Baker Street, which is a heavily trafficked thoroughfare and major connector to and from the Golden Gate Bridge. This NCD offers a wide variety of goods and services to a population greater than the immediate neighborhood, including motels, eating and drinking establishments, auto related uses and other retail stores. Housing development in new buildings is encouraged above the first story in the subject zoning district

4. **Project Description.** The proposal is to demolish the existing one- story vacant commercial building that was last occupied by a restaurant, and construct with a four-story mixed-use building. The project proposes to merge the two lots resulting in a lot containing approximately 12,850 square feet of lot area and approximately 131 feet of lot frontage. The proposal will maintain the existing vehicular easement from the rear abutting property to Lombard Street by providing a garage door along the rear property line.

The proposed 40 foot tall building comprises three stories of residential units over ground floor commercial space and residential parking. Project features include 21 dwelling units, two commercial spaces, 2,516 square feet of common usable open space on the roof deck, 4,552 square feet of private usable open space, 28 residential parking spaces, and 22 Class 1 bicycle storage spaces. The proposed unit mix includes three one-bedroom units of approximately 703 square feet, and 18 two-bedroom units ranging from 1,138 to 1,264 square feet. The sponsor has elected to pay an in-lieu fee to comply with Planning Code Section 415, the Inclusionary Affordable Housing Fee

5. **Public Comment.** The Department has not received any comments to date.
6. **Planning Code Compliance:** The Commission finds that the Project is consistent with the relevant provisions of the Planning Code in the following manner:

- A. **Lot Size.** Planning Code Section 712.11 permits as-of-right a lot size of up to 9,999 square feet.

The proposed lot merger of lots 0025 and 026 would result in a new lot area of approximately 12,850 square feet, which is in excess of the lot size limit and thus requires a Conditional Use authorization.

- B. **Residential Density.** Planning Code Section 712.91 permits a density ratio of 1 dwelling unit for each 600 square feet of lot area.

At approximately 12,850 square feet of lot area, 21 dwelling units are permitted on the proposed new lot. The proposed unit count complies with the prescribed density.

- C. **Rear Yard Requirement.** Planning Code Section 134 requires, in NC-3 Districts, a rear yard measuring 25 percent of the total lot depth at all residential levels.

The Project proposes an approximately 26-foot, 6 inches rear yard for the portion of the proposed lot with a depth of approximately 106 feet at the residential floors, and no rear yard for the proposed portion of the lot with a depth of approximately 59 feet at the residential floors. A rear yard modification is required for this project to be considered by the Zoning Administrator under Case No. 2009.1177V.

- D. **Parking.** Planning Code Section 151 requires one parking space for each dwelling unit. Planning Code Section 204.5 permits up to 150 percent of the required number of spaces where three or more spaces are required.

The Project proposes 28 off-street parking spaces for residential use. Twenty-one parking spaces are required and seven permitted accessory parking spaces are proposed. Fourteen of the parking spaces will utilize a parking lift.

- E. **Bicycle Parking.** Planning Code Section 155 requires one Class 1 Bicycle Parking space for every dwelling unit and one Class 2 Bicycle Parking space for every 20 dwelling units. Class 1 Bicycle Parking Space is defined as spaces in secure, weather-protected facilities intended for use as long-term, overnight, and work-day bicycle storage by dwelling unit residents, non-residential occupants, and Employees. Class 2 Bicycle Parking Space is defined as bicycle racks located in a publicly-accessible, highly visible location intended for transient or short-term use by visitors, guests, and patrons to the building or use.

The project proposes to provide 22 Bicycle Parking Spaces in two separate locations on the ground floor that will satisfy the bicycle parking requirements. The one required Class 2 Bicycle Parking Space will not be locked and will be accessible to visitors via building lobby.

- F. **Height.** Planning Code Section 260 requires that all structures be no taller than the height prescribed in the subject height and bulk district. The proposed Project is located in a 40-X Height and Bulk District, with a 40-foot height limit.

The project proposes to construct a building of 40 feet in height. Stair, elevator and mechanical penthouses would extend above the roof height and are exempted from the height limit per Planning Code Section 260(b).

- G. **Open Space.** Planning Code Section 135 requires 100 square feet of common usable open space or 80 square feet of private usable open space per dwelling unit.

The Project proposes to provide approximately 618 to 846 square feet of private usable open space for each of the three dwelling units (units #202, #204, and #206) abutting the second floor rear roof deck. Approximately 2,516 square feet of common usable open space will be provided for the remaining 18 dwelling units at the fourth-story roof deck, where 1,800 square feet is required.

- H. **Street Trees.** Planning Code Section 138.1 requires one tree of 24-inch box size for each 20 feet of frontage of the property along each street or alley.

The site's Lombard Street frontage is 131 feet, and would require seven total street trees. There are currently three existing street trees and the project proposes four new street trees to meet a total of seven street trees within the sidewalk in front of the proposed building.

- I. **Inclusionary Affordable Housing Program.** Planning Code Section 415 sets forth the requirements and procedures for the Inclusionary Affordable Housing Program. Under Planning Code Section 415.3, the current percentage requirements apply to projects that consist of ten or more units, where the first application (Environmental Evaluation or Building Permit Application) was applied for on or after July 18, 2006. Pursuant to Planning Code Section 415.5, the Project must pay the Affordable Housing Fee ("Fee"). This Fee is made payable to the Department of Building Inspection ("DBI") for use by the Mayor's Office of Housing for the purpose of increasing affordable housing citywide.

The Project Sponsor has submitted an 'Affidavit of Compliance with the Inclusionary Affordable Housing Program: Planning Code Section 415,' to satisfy the requirements of the Inclusionary Affordable Housing Program through payment of the Fee, in an amount to be established by the Mayor's Office of Housing at a rate equivalent to an off-site requirement of 20%. The project sponsor has not selected an alternative to payment of the Fee.

- J. **Street Frontage in Neighborhood Commercial Districts.** Section 145.1 of the Planning Code requires the following:

1. **Above-Grade Parking Setback.** Off-street parking at street grade on a development lot must be set back at least 25 feet from the front of the development on the ground floor.

All proposed parking is set back a minimum of 32 feet from the front building wall.

2. **Parking and Loading Entrances.** No more than one-third of the width or 20 feet, whichever is less, of any given street frontage of a new structure parallel to and facing a street shall be devoted to parking and loading ingress or egress. Street-facing garage structures and garage doors may not extend closer to the street than a primary building facade unless the garage structure and garage door are consistent with the features listed in Section [136](#) of this Code. The total street frontage dedicated to parking and loading access should be minimized, and combining entrances for off-street parking with those for off-street loading is encouraged. The placement of parking and loading entrances should minimize interference with street-fronting active uses and with the movement of pedestrians, cyclists, public transit, and autos. Off-street parking and loading entrances should minimize the loss of on-street parking and loading spaces.

The proposed parking entrance along Lombard Street is 12 feet wide. The existing curb cut is proposed to be reduced from 35 feet wide to 10 feet wide, which will result in an increase of on-street parking. No loading entrance is proposed. The proposed rear easement entrance is 9 feet wide.

3. **Active Uses Required.** With the exception of space allowed for parking and loading access, building egress, and access to mechanical systems, space for active uses shall be provided within the first 25 feet of building depth on the ground floor from any facade facing a street at least 30 feet in width. Building systems including mechanical, electrical, and plumbing features may be exempted from this requirement by the Zoning Administrator only in instances where those features are provided in such a fashion as to not negatively impact the quality of the ground floor space.

Active ground floor uses are proposed within the first 25 feet of the building depth on the ground floor. All mechanical features are minimized and have been designed to integrate with the building façade.

4. **Ground Floor Ceiling Height.** Ground floor non-residential uses in NC districts shall have a minimum floor-to-floor height of 10 feet in a 40-foot height districts.

The proposed ground floor ceiling height will be a minimum of 10 feet tall.

5. **Street-Facing Ground-Level Spaces.** The floors of street-fronting interior spaces housing non-residential active uses and lobbies shall be as close as possible to the level of the adjacent sidewalk at the principal entrance to these spaces.

The proposed active uses and residential lobby are designed within one foot of the sidewalk.

6. **Transparency and Fenestration.** Frontages with active uses that are not residential must be fenestrated with transparent windows and doorways for no less than 60 percent of the street frontage at the ground level and allow visibility to the inside of the building. The use of dark or mirrored glass shall not count towards the required transparent area.

The project contains 76 feet of total commercial frontage, 13 feet of residential lobby, and 5 feet is dedicated to a second means of egress, for a total of 94 feet of active uses. Approximately 64 feet 6 inches is dedicated to windows and doors, providing approximately 69 percent of transparency and fenestration.

7. **Gates, Railings, and Grillwork.** Any decorative railings or grillwork, other than wire mesh, which is placed in front of or behind ground floor windows, shall be at least 75 percent open to perpendicular view. Rolling or sliding security gates shall consist of open grillwork rather than solid material, so as to provide visual interest to pedestrians when the gates are closed, and to permit light to pass through mostly unobstructed. Gates,

when both open and folded or rolled as well as the gate mechanism, shall be recessed within, or laid flush with, the building façade.

No gates, railing or grillwork is proposed to conceal windows. A perforated garage door and transformer door are proposed.

7. **Planning Code Section 303** establishes criteria for the Planning Commission to consider when reviewing applications for Conditional Use approval. On balance, the project does comply with said criteria in that:

- A. The proposed new uses and building, at the size and intensity contemplated and at the proposed location, will provide a development that is necessary or desirable, and compatible with, the neighborhood or the community.

The use and size of the proposed project is compatible with the immediate neighborhood. The existing single-story approximately 2,500 square foot vacant commercial space and parking lot located on a 12,850 square foot site are underutilized at an FAR (Floor Area Ratio) of 0.2:1. The new building would provide 21 new dwelling units, the majority of which are family-sized units, parking, usable private and common open space and an increase of commercial space to approximately 2,715 square feet. The replacement building is similar in height and scale to the surrounding mixed-use buildings and is consistent with the density requirements of the NC-3 District. The replacement building is designed to be in keeping with the existing development pattern and the neighborhood character through a defined base with active uses, a consistent window pattern and strong vertical elements in appropriate modulations, and a well-defined termination to the top of the building.

- B. The proposed project will not be detrimental to the health, safety, convenience or general welfare of persons residing or working in the vicinity. There are no features of the project that could be detrimental to the health, safety or convenience of those residing or working the area, in that:

- i. Nature of proposed site, including its size and shape, and the proposed size, shape and arrangement of structures;

The subject lots have historically been utilized as a single lot, in that the existing single-story vacant commercial building was constructed on both lots. The proposed merger of the irregularly shaped lot containing an existing vehicular easement from the rear abutting property fronting on Greenwich Street with the rectangular lot will result in a development lot with more flexibility. The existing irregularly shaped lot would be challenging to develop independently due to the need to preserve the existing easement for legal non-conforming parking for an adjacent lot. Furthermore, the merger of the two lots will allow the development of a larger ground floor commercial space, which is consistent with the existing commercial uses along Lombard Street. The existing block does not have a well-defined mid-block pattern and many structures project within this area. The proposed project is developed to the existing rear retaining wall that abuts the rear property line at the ground floor and will provide a setback of 26 feet, 6 inches for all residential floors for the majority of the site. The portion of the site with a shallow lot depth of

approximately 59 feet will not provide a rear setback; however, it is abutting a vacant lot in the same zoning district. The Project is designed to be compatible with the surrounding neighborhood.

- ii. The accessibility and traffic patterns for persons and vehicles, the type and volume of such traffic, and the adequacy of proposed off-street parking and loading;

The Planning Code requires 21 off-street parking spaces for the replacement building and 28 will be provided. The project site is located along a US Highway and is a major thorough-fare. It is not expected that 28 new parking spaces for residential use will significantly affect traffic conditions. The proposed commercial tenant spaces of 190 square feet and 2,525 square feet do not require parking or loading spaces.

- iii. The safeguards afforded to prevent noxious or offensive emissions such as noise, glare, dust and odor;

The proposed project is primarily residential in nature with approximately 2,715 square feet of total commercial space, which is a nominal increase in commercial floor area from the existing 2,500 square feet. The proposed residential density and commercial intensity are not anticipated to produce noxious or offensive emissions.

- iv. Treatment given, as appropriate, to such aspects as landscaping, screening, open spaces, parking and loading areas, service areas, lighting and signs;

Although designed in a contemporary aesthetic, the façade treatment and materials of the replacement building have been appropriately selected to be harmonious with the existing surrounding neighborhood.

- C. That the use as proposed will comply with the applicable provisions of the Planning Code and will not adversely affect the General Plan.

The Project requires a rear yard modification from Planning Code Section 134, for the substandard lot depth portion of the lot. No rear setback is proposed at residential floors for the portion of the lot with a depth of 59 feet, where 15 feet would be required by the Code. The project is consistent with objectives and policies of the General Plan as detailed below.

- D. That the use as proposed would provide development that is in conformity with the purpose of the applicable Neighborhood Commercial District.

The proposed project is consistent with the stated purpose of the NC-3 Districts.

- 8. **General Plan Compliance.** The Project is, on balance, consistent with the following Objectives and Policies of the General Plan:

HOUSING ELEMENT

OBJECTIVE 2:

RETAIN EXISTING HOUSING UNITS, AND PROMOTE SAFETY AND MAINTENANCE STANDARDS, WITHOUT JEOPARDIZING AFFORDABILITY.

Policy 2.1:

Discourage the demolition of sound existing housing, unless the demolition results in a net increase in affordable housing.

No existing dwelling units will be demolished.

URBAN DESIGN

OBJECTIVE 1:

EMPHASIS OF THE CHARACTERISTIC PATTERN WHICH GIVES TO THE CITY AND ITS NEIGHBORHOODS AN IMAGE, A SENSE OF PURPOSE, AND A MEANS OF ORIENTATION.

Policy 1.3:

Recognize that buildings, when seen together, produce a total effect that characterizes the city and its districts.

The project proposes a development that will strengthen the street wall by constructing an appropriately designed building at the front lot line and replacing the existing single-story commercial building and parking lot. The proposed 40 foot tall mixed-use building will be more consistent with the prevailing building heights and building uses in the neighborhood, and will bring an improved aesthetic to the neighborhood.

OBJECTIVE 2:

CONSERVATION OF RESOURCES WHICH PROVIDE A SENSE OF NATURE, CONTINUITY WITH THE PAST, AND FREEDOM FROM OVERCROWDING.

Policy 2.6:

Respect the character of older development nearby in the design of new buildings.

The massing of the replacement building has been designed to be compatible with the prevailing street wall height of the subject NC-3 District. The building has been designed to maintain a clear delineation of a commercial ground floor with residential uses above. The building façade is expressed vertically to be consistent with the immediate neighborhood character. The proposed wood and stucco façade has been designed to be compatible with the other mixed-use buildings found in the area.

9. **Planning Code Section 101.1(b)** establishes eight priority-planning policies and requires review of permits for consistency with said policies. On balance, the project does comply with said policies in that:

- A. That existing neighborhood-serving retail uses be preserved and enhanced and future opportunities for resident employment in and ownership of such businesses be enhanced.

Existing neighborhood-serving retail uses would not be displaced or otherwise adversely affected by the proposal. The existing commercial building has been vacant since 2011. The proposed mixed-use development will replace the commercial space to be demolished and increase the site's commercial square footage by approximately 215 square feet. New commercial activity and employment opportunities will be created as a result of this development.

- B. That existing housing and neighborhood character be conserved and protected in order to preserve the cultural and economic diversity of our neighborhoods.

No existing housing would be affected. The existing neighborhood character will be conserved in that the proposed replacement building has been designed to be compatible with the surrounding mass and scale. The addition of new dwelling units and commercial space will increase the economic diversity of the neighborhood.

- C. That the City's supply of affordable housing be preserved and enhanced,

No existing affordable housing will be affected. The sponsor will contribute to the development of affordable housing through payment of an in-lieu fee, and the project will increase the number of dwelling units in the City's housing stock by 21.

- D. That commuter traffic not impede MUNI transit service or overburden our streets or neighborhood parking.

The Project will not have a significant adverse effect on automobile traffic congestion or increase parking demand in the neighborhood. The replacement building will provide 28 residential off-street parking spaces for 21 dwelling units. Twenty-two bicycle parking spaces will also be provided.

- E. That a diverse economic base be maintained by protecting our industrial and service sectors from displacement due to commercial office development, and that future opportunities for resident employment and ownership in these sectors be enhanced.

The proposal is to construct a new mixed-use building containing approximately 2,525 square feet of commercial space to be occupied by a use that complies with the Planning Code. An additional 190 square feet of ground floor commercial space will be used for principally permitted business or professional services, in the form of a real estate management office for the property owner. The commercial space will create an opportunity for resident employment and ownership in sectors permitted by the Planning Code.

- F. That the City achieve the greatest possible preparedness to protect against injury and loss of life in an earthquake.

The replacement structure would be built in compliance with San Francisco's current Building Code Standards and would meet all earthquake safety requirements.

- G. That landmarks and historic buildings be preserved.

Landmark or historic buildings do not occupy the Project site.

- H. That our parks and open space and their access to sunlight and vistas be protected from development.

The project will have no negative effect on existing parks and open spaces. The project does not exceed the 40-foot height limit, and is thus not subject to the requirements of Planning Code Section 295 – Height Restrictions on Structures Shadowing Property Under the Jurisdiction of the Recreation and Park Commission. The height of the proposed structures is compatible with the established neighborhood development.

10. The Project is consistent with and would promote the general and specific purposes of the Code provided under Section 101.1(b) in that, as designed, the Project would contribute to the character and stability of the neighborhood and would constitute a beneficial development.
11. The Commission hereby finds that approval of the Conditional Use authorization would promote the health, safety and welfare of the City.

DECISION

That based upon the Record, the submissions by the Applicant, the staff of the Department and other interested parties, the oral testimony presented to this Commission at the public hearings, and all other written materials submitted by all parties, the Commission hereby **APPROVES Conditional Use Application No. 2009.1177CV** subject to the following conditions attached hereto as "EXHIBIT A" in general conformance with plans on file, dated October 25, 2013, and stamped "EXHIBIT B", which is incorporated herein by reference as though fully set forth.

APPEAL AND EFFECTIVE DATE OF MOTION: Any aggrieved person may appeal this Conditional Use Authorization to the Board of Supervisors within thirty (30) days after the date of this Motion No. XXXXX. The effective date of this Motion shall be the date of this Motion if not appealed (After the 30-day period has expired) OR the date of the decision of the Board of Supervisors if appealed to the Board of Supervisors. For further information, please contact the Board of Supervisors at (415) 554-5184, City Hall, Room 244, 1 Dr. Carlton B. Goodlett Place, San Francisco, CA 94102.

I hereby certify that the Planning Commission ADOPTED the foregoing Motion on December 19, 2013.

Jonas P. Ionin
Acting Commission Secretary

AYES:

NAYS:

ABSENT:

ADOPTED: December 19, 2013

EXHIBIT A

AUTHORIZATION

This authorization is for a conditional use to allow the demolition of a vacant one-story commercial building and construction of a four-story mixed-use building containing 21 dwelling units, approximately 27,00 square feet of commercial space and 28 residential parking spaces. This project will merge two lots resulting in a lot size in excess of 10,000 square feet, located at 2353 Lombard Street, Block 0512, and Lots 025 and 026, pursuant to Planning Code Sections 121 and 303 within the NC-3 District and a 40-X Height and Bulk District; in general conformance with plans, dated October 25, 2013, and stamped "EXHIBIT B" included in the docket for Case No. 209.1177CV and subject to conditions of approval reviewed and approved by the Commission on **December 19, 2013**, under Motion No **XXXXXX**. This authorization and the conditions contained herein run with the property and not with a particular Project Sponsor, business, or operator.

RECORDATION OF CONDITIONS OF APPROVAL

Prior to the issuance of the building permit or commencement of use for the Project the Zoning Administrator shall approve and order the recordation of a Notice in the Official Records of the Recorder of the City and County of San Francisco for the subject property. This Notice shall state that the project is subject to the conditions of approval contained herein and reviewed and approved by the Planning Commission on **December 19, 2013**, under Motion No **XXXXXX**.

PRINTING OF CONDITIONS OF APPROVAL ON PLANS

The conditions of approval under the 'Exhibit A' of this Planning Commission Motion No. **XXXXXX** shall be reproduced on the Index Sheet of construction plans submitted with the Site or Building permit application for the Project. The Index Sheet of the construction plans shall reference to the Conditional Use authorization and any subsequent amendments or modifications.

SEVERABILITY

The Project shall comply with all applicable City codes and requirements. If any clause, sentence, section or any part of these conditions of approval is for any reason held to be invalid, such invalidity shall not affect or impair other remaining clauses, sentences, or sections of these conditions. This decision conveys no right to construct, or to receive a building permit. "Project Sponsor" shall include any subsequent responsible party.

CHANGES AND MODIFICATIONS

Changes to the approved plans may be approved administratively by the Zoning Administrator. Significant changes and modifications of conditions shall require Planning Commission approval of a new Conditional Use authorization.

Conditions of Approval, Compliance, Monitoring, and Reporting

PERFORMANCE

1. **Validity.** The authorization and right vested by virtue of this action is valid for three (3) years from the effective date of the Motion. The Department of Building Inspection shall have issued a Building Permit or Site Permit to construct the project and/or commence the approved use within this three-year period.

For information about compliance, contact Code Enforcement, Planning Department at 415-575-6863, www.sf-planning.org

2. **Expiration and Renewal.** Should a Building or Site Permit be sought after the three (3) year period has lapsed, the project sponsor must seek a renewal of this Authorization by filing an application for an amendment to the original Authorization or a new application for Authorization. Should the project sponsor decline to so file, and decline to withdraw the permit application, the Commission shall conduct a public hearing in order to consider the revocation of the Authorization. Should the Commission not revoke the Authorization following the closure of the public hearing, the Commission shall determine the extension of time for the continued validity of the Authorization.

For information about compliance, contact Code Enforcement, Planning Department at 415-575-6863, www.sf-planning.org

3. **Diligent pursuit.** Once a site or Building Permit has been issued, construction must commence within the timeframe required by the Department of Building Inspection and be continued diligently to completion. Failure to do so shall be grounds for the Commission to consider revoking the approval if more than three (3) years have passed since this Authorization was approved.

For information about compliance, contact Code Enforcement, Planning Department at 415-575-6863, www.sf-planning.org

4. **Extension.** All time limits in the preceding three paragraphs may be extended at the discretion of the Zoning Administrator where implementation of the project is delayed by a public agency, an appeal or a legal challenge and only by the length of time for which such public agency, appeal or challenge has caused delay.

For information about compliance, contact Code Enforcement, Planning Department at 415-575-6863, www.sf-planning.org

5. **Conformity with Current Law.** No application for Building Permit, Site Permit, or other entitlement shall be approved unless it complies with all applicable provisions of City Codes in effect at the time of such approval.

For information about compliance, contact Code Enforcement, Planning Department at 415-575-6863, www.sf-planning.org

DESIGN

6. **Final Materials.** The Project Sponsor shall continue to work with Planning Department on the building design. Final materials, glazing, color, texture, landscaping, and detailing shall be subject to Department staff review and approval. The architectural addenda shall be reviewed and approved by the Planning Department prior to issuance.
For information about compliance, contact the Case Planner, Planning Department at 415-558-6378, www.sf-planning.org
7. **Garbage, composting and recycling storage.** Space for the collection and storage of garbage, composting, and recycling shall be provided within enclosed areas on the property and clearly labeled and illustrated on the architectural addenda. Space for the collection and storage of recyclable and compostable materials that meets the size, location, accessibility and other standards specified by the San Francisco Recycling Program shall be provided at the ground level of the buildings.
For information about compliance, contact the Case Planner, Planning Department at 415-558-6378, www.sf-planning.org
8. **Rooftop Mechanical Equipment.** Pursuant to Planning Code 141, the Project Sponsor shall submit a roof plan to the Planning Department prior to Planning approval of the building permit application. Rooftop mechanical equipment, if any is proposed as part of the Project, is required to be screened so as not to be visible from any point at or below the roof level of the subject building.
For information about compliance, contact the Case Planner, Planning Department at 415-558-6378, www.sf-planning.org
9. **Transformer Vault.** The sponsor has indicated that the transformer vaults can be located below the sidewalk or within the basement of the building.

The location of individual project PG&E Transformer Vault installations has significant effects to San Francisco streetscapes when improperly located. However, they may not have any impact if they are installed in preferred locations. Therefore, the Planning Department recommends the following preference schedule in locating new transformer vaults, in order of most to least desirable:

- a) On-site, in a basement area accessed via a garage or other access point without use of separate doors on a ground floor façade facing a public right-of-way;
- b) On-site, in a driveway, underground;
- c) On-site, above ground, screened from view, other than a ground floor façade facing a public right-of-way;
- d) Public right-of-way, underground, under sidewalks with a minimum width of 12 feet, avoiding effects on streetscape elements, such as street trees; and based on Better Streets Plan guidelines;
- e) Public right-of-way, underground; and based on Better Streets Plan guidelines;
- f) Public right-of-way, above ground, screened from view; and based on Better Streets Plan guidelines;

g) On-site, in a ground floor façade (the least desirable location).

Unless otherwise specified by the Planning Department, Department of Public Work's Bureau of Street Use and Mapping (DPW BSM) should use this preference schedule for all new transformer vault installation requests.

For information about compliance, contact Bureau of Street Use and Mapping, Department of Public Works at 415-554-5810, <http://sfdpw.org>

10. **Street Trees.** Pursuant to Planning Code Section 138.1 (formerly 143), the Project Sponsor shall submit a site plan to the Planning Department prior to Planning approval of the building permit application indicating that street trees, at a ratio of one street tree of an approved species for every 20 feet of street frontage along public or private streets bounding the Project, with any remaining fraction of 10 feet or more of frontage requiring an extra tree, shall be provided. The street trees shall be evenly spaced along the street frontage except where proposed driveways or other street obstructions do not permit. The exact location, size and species of tree shall be as approved by the Department of Public Works (DPW). In any case in which DPW cannot grant approval for installation of a tree in the public right-of-way, on the basis of inadequate sidewalk width, interference with utilities or other reasons regarding the public welfare, and where installation of such tree on the lot itself is also impractical, the requirements of this Section 428 may be modified or waived by the Zoning Administrator to the extent necessary.

For information about compliance, contact the Case Planner, Planning Department at 415-558-6378, www.sf-planning.org

PARKING AND TRAFFIC

11. **Parking Requirement.** Pursuant to Planning Code Section 151 and the Parking Reeducation Request approved by the Zoning Administrator on July 22, 2013, the Project shall provide 9 independently accessible off-street parking spaces.

For information about compliance, contact Code Enforcement, Planning Department at 415-575-6863, www.sf-planning.org

12. **Bicycle Parking.** The Project shall provide no fewer than 6 Class 1 bicycle parking spaces as required by Planning Code Sections 155.1 and 155.5.

For information about compliance, contact Code Enforcement, Planning Department at 415-575-6863, www.sf-planning.org

13. **Managing Traffic During Construction.** The Project Sponsor and construction contractor(s) shall coordinate with the Traffic Engineering and Transit Divisions of the San Francisco Municipal Transportation Agency (SFMTA), the Police Department, the Fire Department, the Planning Department, and other construction contractor(s) for any concurrent nearby Projects to manage traffic congestion and pedestrian circulation effects during construction of the Project.

For information about compliance, contact Code Enforcement, Planning Department at 415-575-6863, www.sf-planning.org

PROVISIONS

Inclusionary Affordable Housing Program

14. **Requirement.** Pursuant to Planning Code 415.5, the Project Sponsor must pay an Affordable Housing Fee at a rate equivalent to the applicable percentage of the number of units in an off-site project needed to satisfy the Inclusionary Affordable Housing Program Requirement for the principal project. The applicable percentage for this project is twenty percent (20%).
For information about compliance, contact the Case Planner, Planning Department at 415-558-6378, www.sf-planning.org or the Mayor's Office of Housing at 415-701-5500, www.sf-moh.org.
15. **Other Conditions.** The Project is subject to the requirements of the Inclusionary Affordable Housing Program under Section 415 et seq. of the Planning Code and the terms of the City and County of San Francisco Inclusionary Affordable Housing Program Monitoring and Procedures Manual ("Procedures Manual"). The Procedures Manual, as amended from time to time, is incorporated herein by reference, as published and adopted by the Planning Commission, and as required by Planning Code Section 415. Terms used in these conditions of approval and not otherwise defined shall have the meanings set forth in the Procedures Manual. A copy of the Procedures Manual can be obtained at the Mayor's Office of Housing ("MOH") at 1 South Van Ness Avenue or on the Planning Department or Mayor's Office of Housing's websites, including on the internet at:
<http://sf-planning.org/Modules/ShowDocument.aspx?documentid=4451>.
As provided in the Inclusionary Affordable Housing Program, the applicable Procedures Manual is the manual in effect at the time the subject units are made available for sale or rent.
For information about compliance, contact the Case Planner, Planning Department at 415-558-6378, www.sf-planning.org or the Mayor's Office of Housing at 415-701-5500, www.sf-moh.org.
- a. The Project Sponsor must pay the Fee in full sum to the Development Fee Collection Unit at the DBI for use by MOH prior to the issuance of the first construction document, with an option for the Project Sponsor to defer a portion of the payment prior to issuance of the first certificate of occupancy upon agreeing to pay a deferral surcharge that would be deposited into the Citywide Inclusionary Affordable Housing Fund in accordance with Section 107A.13.3 of the San Francisco Building Code.
- b. Prior to the issuance of the first construction permit by the DBI for the Project, the Project Sponsor shall record a Notice of Special Restriction on the property that records a copy of this approval. The Project Sponsor shall promptly provide a copy of the recorded Notice of Special Restriction to the Department and to MOH or its successor.
- c. If project applicant fails to comply with the Inclusionary Affordable Housing Program requirement, the Director of DBI shall deny any and all site or building permits or certificates of occupancy for the development project until the Planning Department notifies the Director of compliance. A Project Sponsor's failure to comply with the requirements of Planning Code Sections 415 et seq. shall constitute cause for the City to record a lien against the development project and to pursue any and all other remedies at law.

16. **First Source Hiring.** The Project shall adhere to the requirements of the First Source Hiring Construction and End-Use Employment Program approved by the First Source Hiring Administrator, pursuant to Section 83.4(m) of the Administrative Code. The Project Sponsor shall comply with the requirements of this Program regarding construction work and on-going employment required for the Project.

For information about compliance, contact the First Source Hiring Manager at 415-581-2335, www.onestopSF.org

MONITORING

17. **Enforcement.** Violation of any of the Planning Department conditions of approval contained in this Motion or of any other provisions of Planning Code applicable to this Project shall be subject to the enforcement procedures and administrative penalties set forth under Planning Code Section 176 or Section 176.1. The Planning Department may also refer the violation complaints to other city departments and agencies for appropriate enforcement action under their jurisdiction.

For information about compliance, contact Code Enforcement, Planning Department at 415-575-6863, www.sf-planning.org

18. **Revocation due to Violation of Conditions.** Should implementation of this Project result in complaints from interested property owners, residents, or commercial lessees which are not resolved by the Project Sponsor and found to be in violation of the Planning Code and/or the specific conditions of approval for the Project as set forth in Exhibit A of this Motion, the Zoning Administrator shall refer such complaints to the Commission, after which it may hold a public hearing on the matter to consider revocation of this authorization.

For information about compliance, contact Code Enforcement, Planning Department at 415-575-6863, www.sf-planning.org

OPERATION

19. **Sidewalk Maintenance.** The Project Sponsor shall maintain the main entrance to the building and all sidewalks abutting the subject property in a clean and sanitary condition in compliance with the Department of Public Works Streets and Sidewalk Maintenance Standards. *For information about compliance, contact Bureau of Street Use and Mapping, Department of Public Works, 415-695-2017, <http://sfdpw.org/>*

20. **Lighting.** All Project lighting shall be directed onto the Project site and immediately surrounding sidewalk area only, and designed and managed so as not to be a nuisance to adjacent residents. Nighttime lighting shall be the minimum necessary to ensure safety, but shall in no case be directed so as to constitute a nuisance to any surrounding property.

For information about compliance, contact Code Enforcement, Planning Department at 415-575-6863, www.sf-planning.org

21. **Garbage, Recycling, and Composting Receptacles.** Garbage, recycling, and compost containers shall be kept within the premises and hidden from public view, and placed outside only when

being serviced by the disposal company. Trash shall be contained and disposed of pursuant to garbage and recycling receptacles guidelines set forth by the Department of Public Works.

For information about compliance, contact Bureau of Street Use and Mapping, Department of Public Works at 415-554-.5810, <http://sfdpw.org>

22. **Community Liaison.** Prior to issuance of a building permit to construct the project and implement the approved use, the Project Sponsor shall appoint a community liaison officer to deal with the issues of concern to owners and occupants of nearby properties. The Project Sponsor shall provide the Zoning Administrator with written notice of the name, business address, and telephone number of the community liaison. Should the contact information change, the Zoning Administrator shall be made aware of such change. The community liaison shall report to the Zoning Administrator what issues, if any, are of concern to the community and what issues have not been resolved by the Project Sponsor.

For information about compliance, contact Code Enforcement, Planning Department at 415-575-6863, www.sf-planning.org

Parcel Map

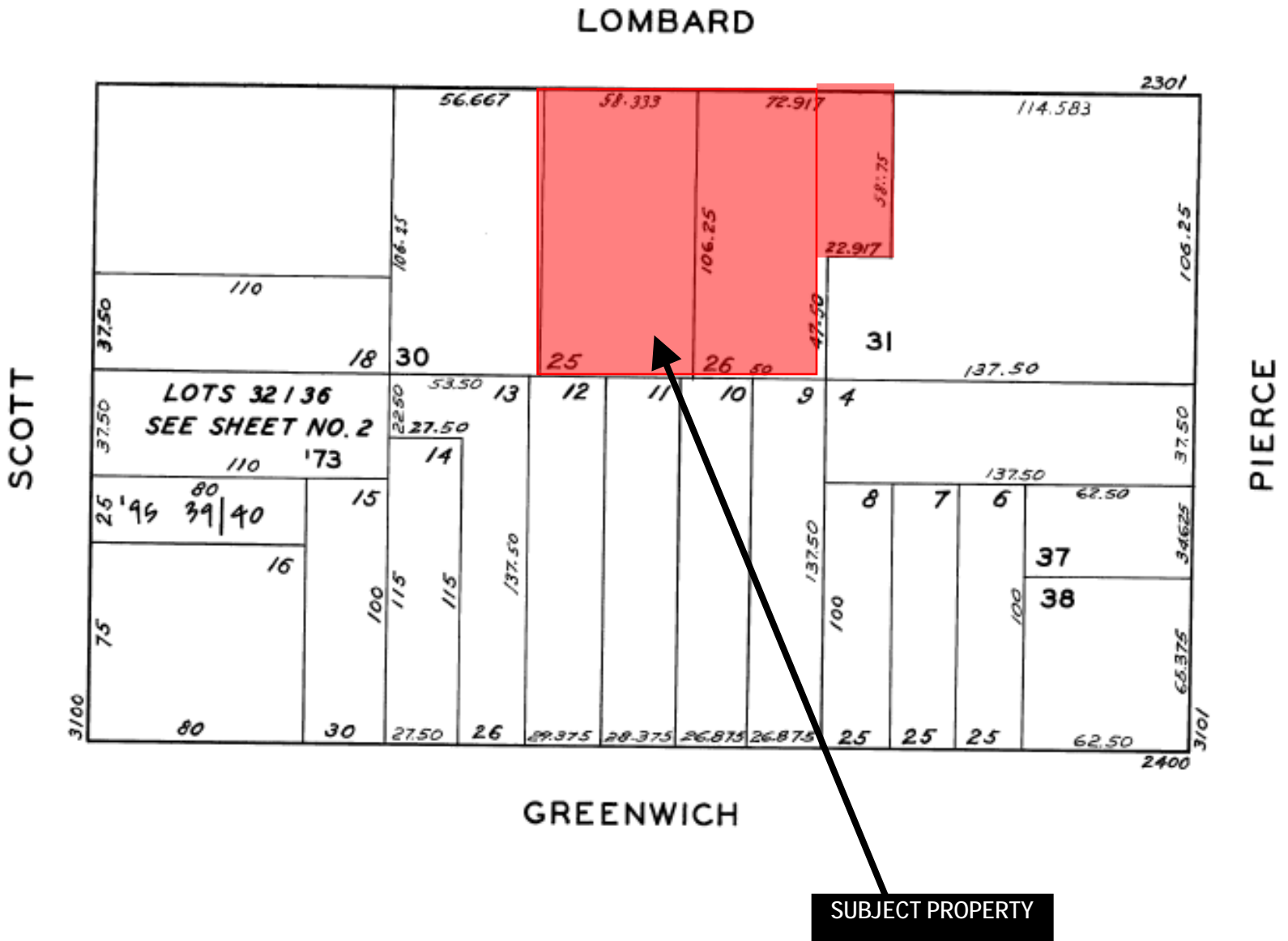

Conditional Use Authorization
Case Number 2009.1177CV
 Lot Size Conditional Use Authorization
 2535 Lombard Street

Sanborn Map*

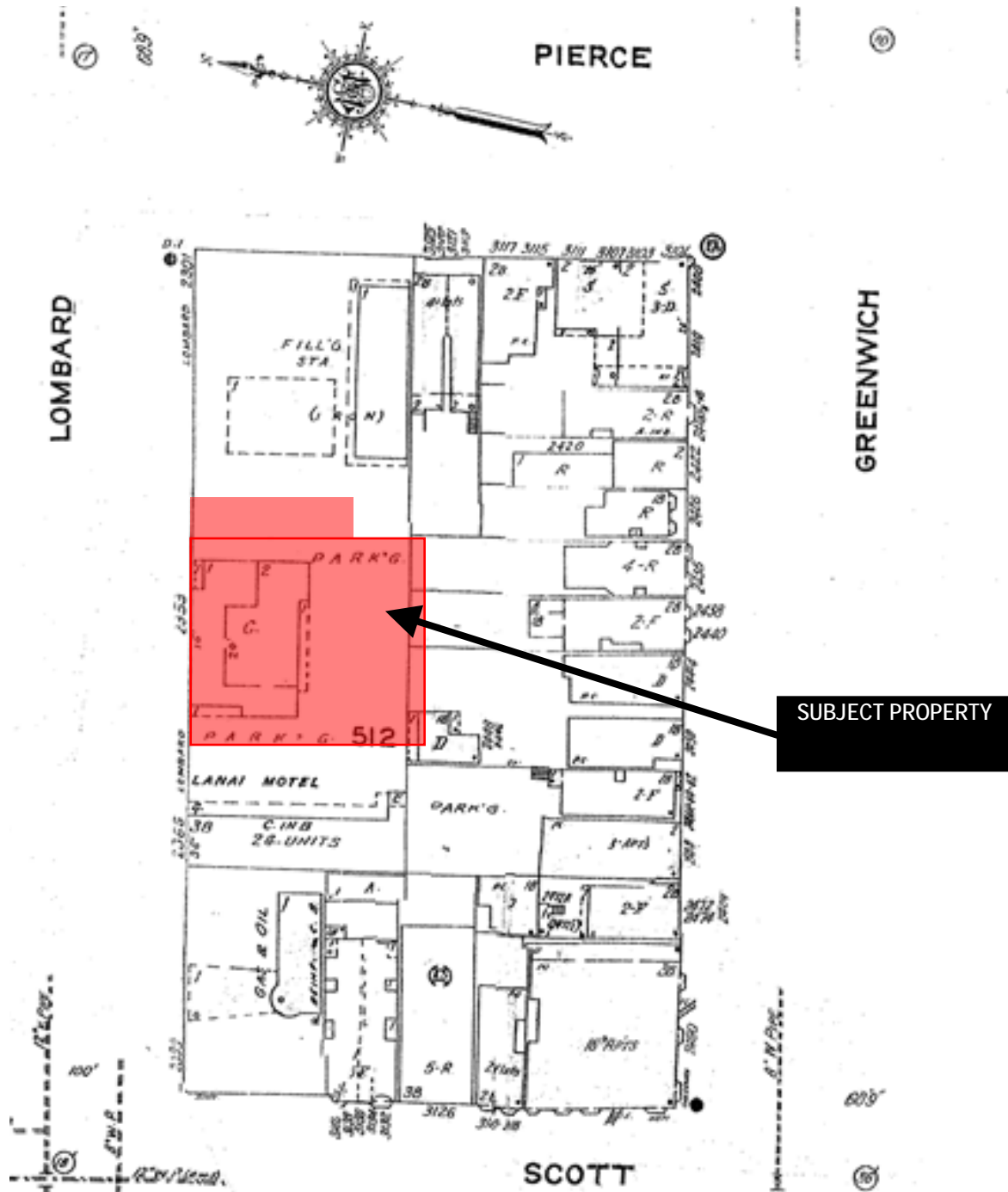

*The Sanborn Maps in San Francisco have not been updated since 1998, and this map may not accurately reflect existing conditions.

Conditional Use Authorization
Case Number 2009.1177CV
Lot Size Conditional Use Authorization
2535 Lombard Street

Zoning Map

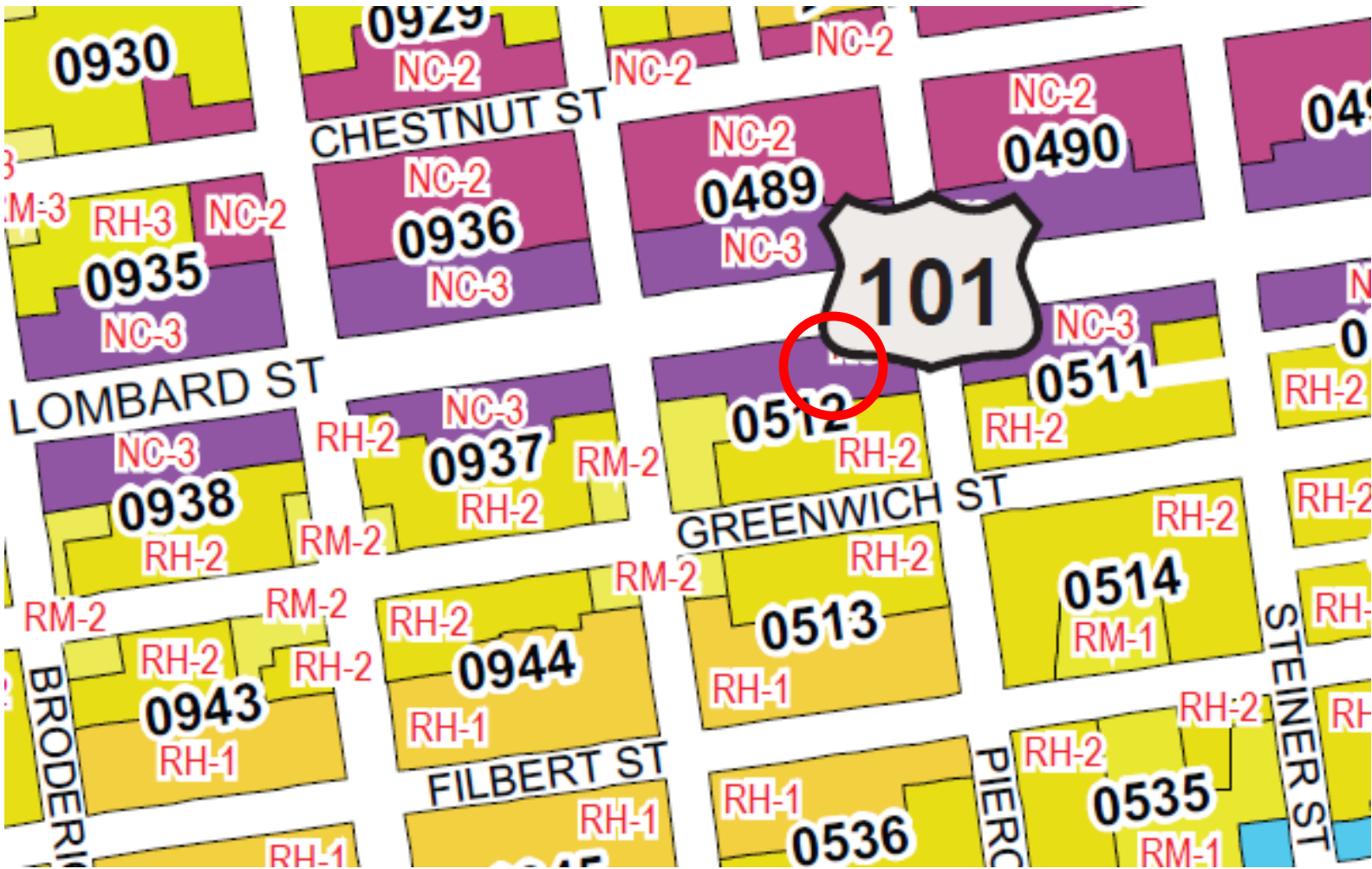

Conditional Use Authorization
Case Number 2009.1177CV
Lot Size Conditional Use Authorization
2535 Lombard Street

Aerial Photo View to North



SUBJECT PROPERTY

Conditional Use Authorization
Case Number 2009.1177CV
Lot Size Conditional Use Authorization
2535 Lombard Street

Aerial Photo View to West



SUBJECT PROPERTY

Conditional Use Authorization
Case Number 2009.1177CV
Lot Size Conditional Use Authorization
2535 Lombard Street

Aerial Photo View to South

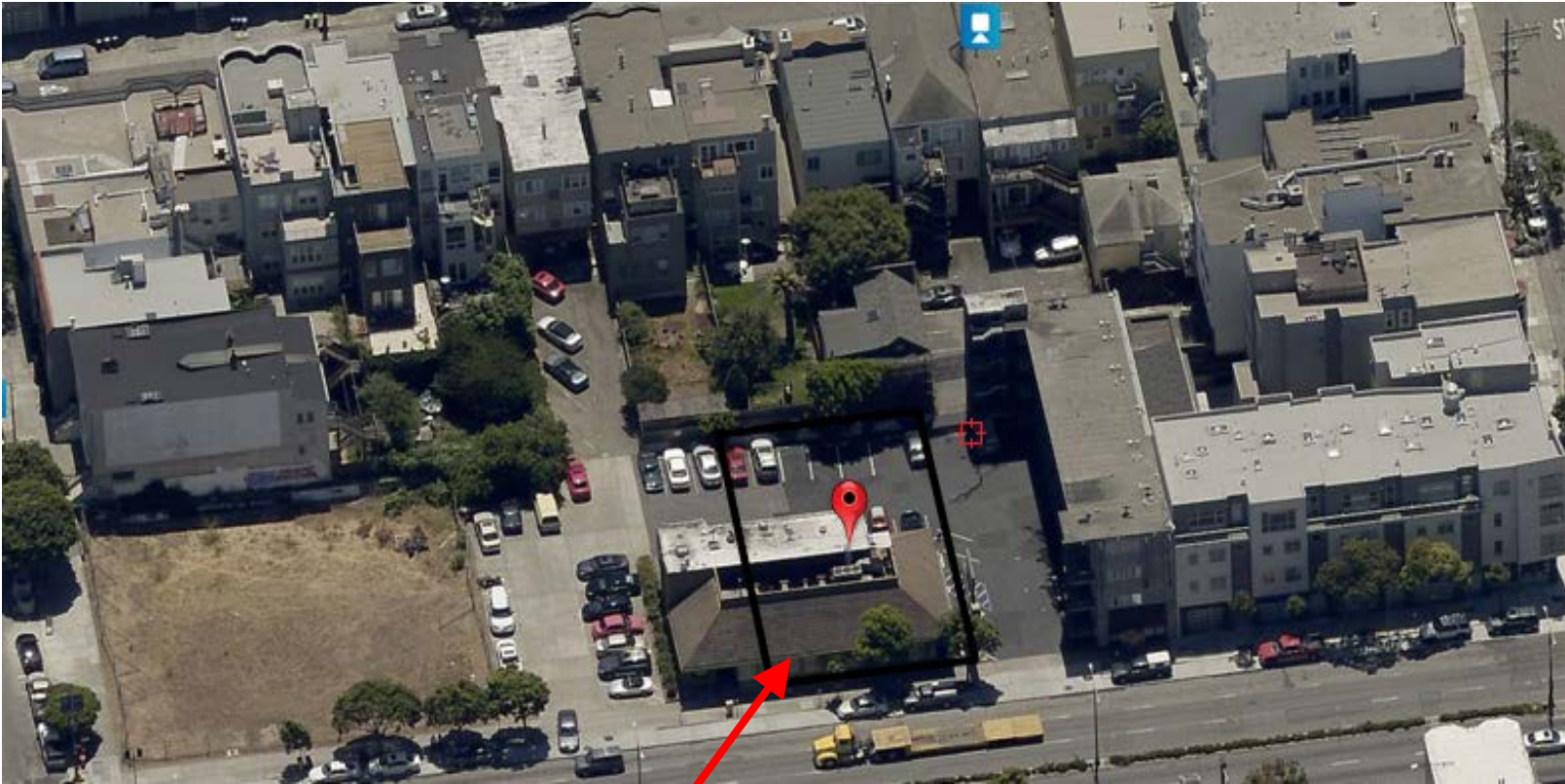

SUBJECT PROPERTY

Conditional Use Authorization
Case Number **2009.1177CV**
Lot Size Conditional Use Authorization
2535 Lombard Street

Site Photo



Conditional Use Authorization
Case Number 2009.1177CV
Lot Size Conditional Use Authorization
2535 Lombard Street

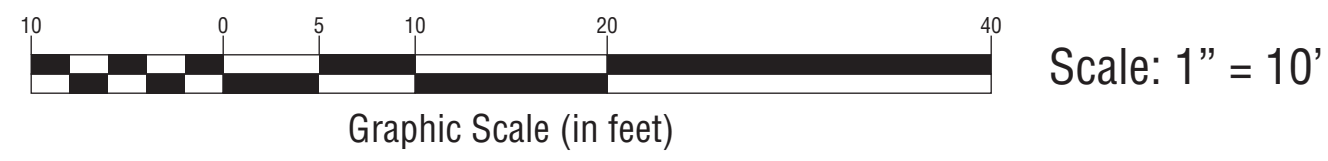
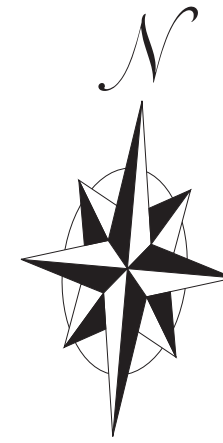

Lombard Street (100' Wide)

Scott Street (68.75' Wide)

Pierce Street (68.75' Wide)

Assessor's Block 0512

Basis of Survey
The grant deed recorded December 8, 2006 in Reel J283 O.R. Image 0063.
Monument map no. 280 on file in the City Engineer's office, San Francisco, California.

Date of Survey
Topographic information shown here is based upon a field survey performed under the supervision of Michael Lemke, L.S. 3602, on November 6, 2009.

Utility Note
Underground utilities shown hereon were plotted from a combination of observed surface evidence (conditions permitting) and record information obtained from the respective utility companies.

Project Benchmark
Elevations shown hereon are based on city datum at the intersection of Lombard Street and Scott Street, SE corner, crow cut outer rim SWI, Elevation: 17.301.

Easement Note
Ingress and Egress Easement as described in the Lease Agreement recorded October 22, 1991 in Reel F486, O.R. Image 0530, Official Records.

Surveyor's Statement:
This map was prepared by me or under my direction and is based upon a field survey made on November 6, 2009.

Date:

American Land Surveying
Michael Lemke
Licensed Surveyor No. 3602
License Expires: June 30, 2010

Legend

- BK back of walk
- COR corner elevation at ground
- SFW water
- EP edge of pavement
- TEL telephone
- GV gas valve
- PGE Pacific Gas & Electric
- PM parking meter
- RF roof
- TC top of curb
- FL flow line
- TW top of wall
- WV water valve

- g- gas line
- s- sanitary sewer line
- oe- overhead electrical line
- ue- underground electrical line
- w- water line
- e- easement line

- tree
- 17.88.028 spot elevation

Topographical Site Survey

Lot 25 (Parcel One) and Lot 26 (Parcel Two), Assessor's Block 0512, as described in the grant deeds recorded on February 10, 1964 in Book A715, Pages 717-719, in the Recorder's office of City and County of San Francisco, State of California

American Land Surveying
Licensed Surveyors

August 2010

Sheet 1 of 1 Sheet

AB: 0512 Lots: 25-26 Address: 2347-2351 Lombard Street

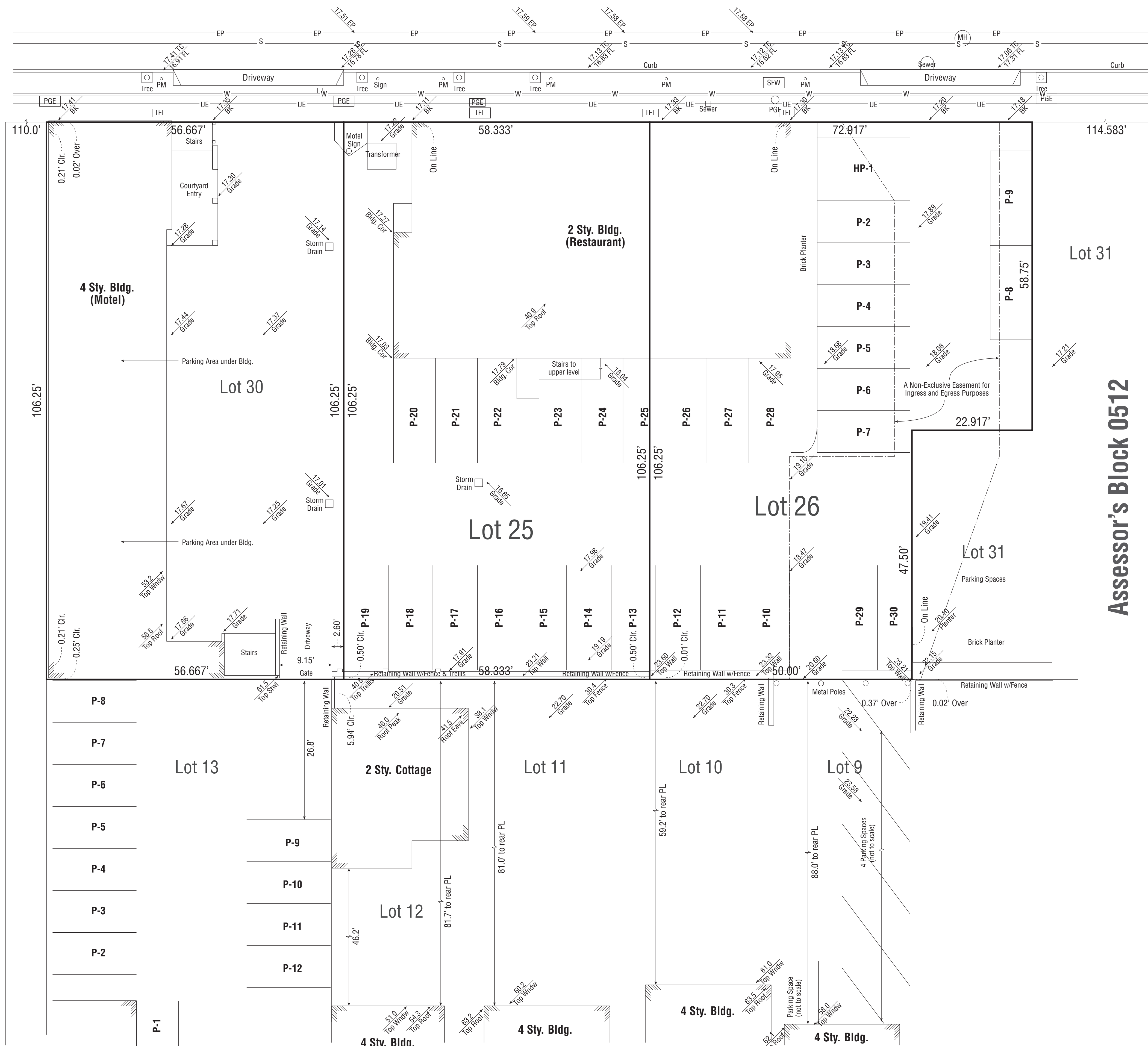

76'-0"

22'-6"

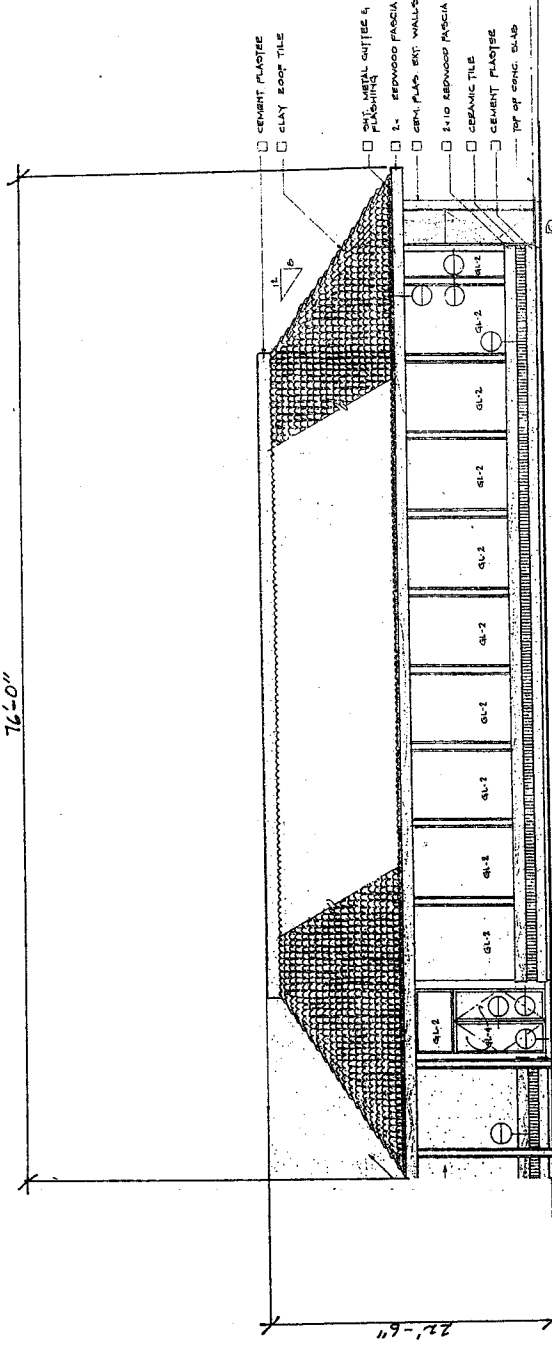

ADJACENT BUILDING

STAIRS

D
 NORTH ELEVATION EXISTING
 2353 LOMBARD SAN FRANCISCO, CA
 SCALE: 1/8" = 1'-0"

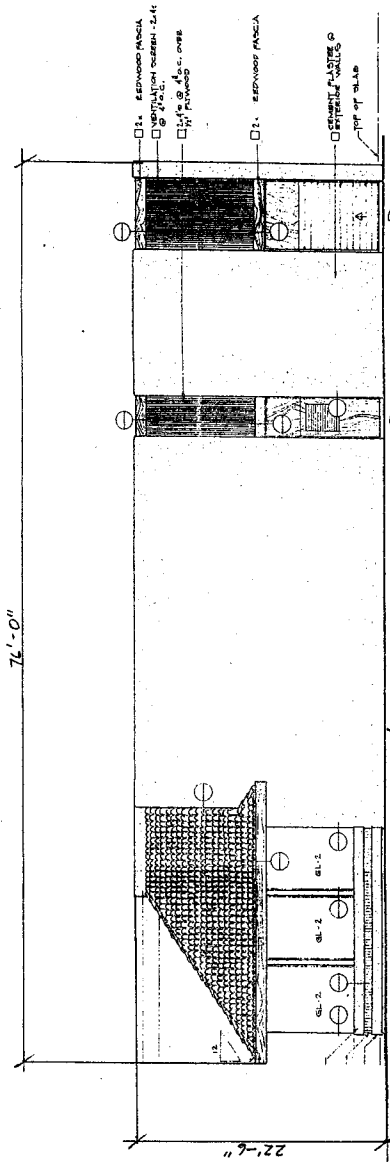
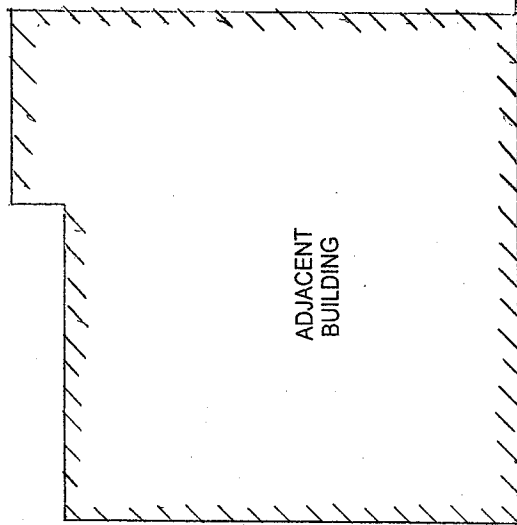

SOUTH ELEVATION EXISTING
 SCALE: 1/8" = 1'-0"
 2353 LOMBARD SAN FRANCISCO, CA

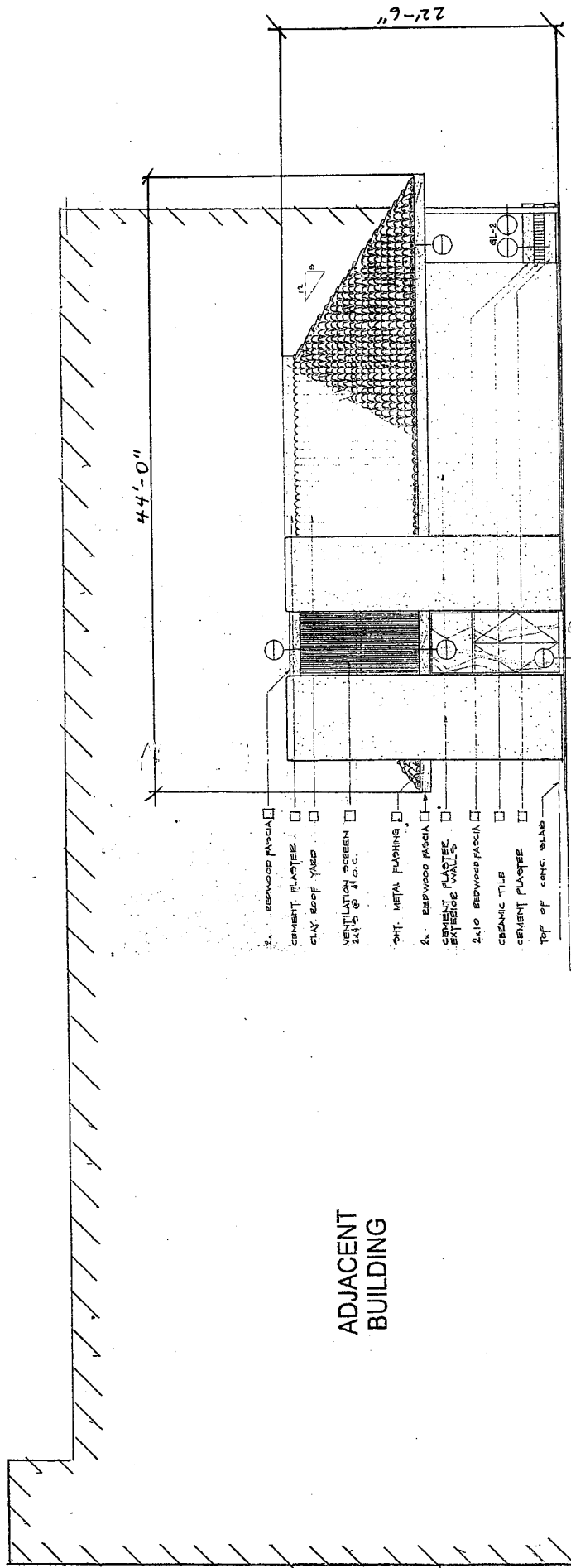

ADJACENT BUILDING

44'-0"

22'-6"

- 3. REDWOOD FASCIA
- CEMENT PLASTER
- CLAY ROOF TILES
- VENTILATION SCREEN 2x4 @ 4' O.C.
- CHT. METAL FLASHING
- 2. REDWOOD FASCIA
- CEMENT ENTRANCE WALLS
- 2x10 REDWOOD FASCIA
- CERAMIC TILE
- CEMENT PLASTER
- TOP OF CONC. SLAB

EAST ELEVATION EXISTING
 2353 LOMBARD SAN FRANCISCO, CA
 SCALE: 1/8" = 1'-0"

VICINITY MAP

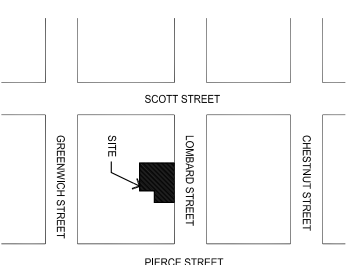

2353
Lombard
Street

San Francisco • California

**GARY
G E E
A I A**

GARY GEE ARCHITECTS, INC.
98 Brady Street, 4th
San Francisco, CA 94103
Tel: 415.398.8879
Fax: 415.398.8879

OFFICIAL CITY OF SAN FRANCISCO ARCHITECTS, INC.
SHEILA WANG, ARCHITECT, LICENSE NO. 10000
AND ALL OTHERS ARE HEREBY CERTIFIED AS
BEING QUALIFIED TO PREPARE ARCHITECTURAL
DRAWINGS AND TO SUPERVISE THE CONSTRUCTION
OF THE PROJECTS DESCRIBED IN THESE DRAWINGS.
DATE OF EXPIRATION: 07/31/2012

SCOPE OF WORK

DEMOLISH (E) 2 STORY RESTAURANT BUILDING.
RECONSTRUCT (E) 2 STORY RESTAURANT BUILDING USING BUILDING FORM
AND CONSTRUCTION METHODS AND MATERIALS TO MEET ALL CITY AND
STATE REQUIREMENTS FOR STRUCTURAL, MECHANICAL, ELECTRICAL,
FLOOR COMMERCIAL AND GROUND FLOOR PRIVATE PARKING GARAGE.

PLANNING DEPARTMENT - PROJECT DESCRIPTION

2353 LOMBARD STREET

PROJECT LOCATION: 2353 LOMBARD STREET, SAN FRANCISCO, CALIFORNIA 94103
BLOCK 512, LOT 25 & 26

PROPOSED USE: 4 STORY MIXED USE BUILDING WITH THREE FLOORS OF
RESIDENTIAL UNITS OVER GROUND FLOOR PRIVATE
PARKING GARAGE AND COMMERCIAL RETAIL SPACE

ZONING: M2.3
40X HEIGHT AND BULK DISTRICT

BUILDING HEIGHT / BULK: PROPOSED: 40'-0"

SETBACKS: FRONT: NONE
REAR: 25% OF LOT AREA AT RESIDENTIAL LEVELS

RESIDENTIAL UNITS PROVIDED: 21 UNITS
PARKING PROVIDED: 28 INDIVIDUAL STALLS
BICYCLE PARKING PROVIDED: 21 CLASS 1 SPACES WITH 4 CLASS II SPACE
RESIDENTIAL OPEN SPACE PROVIDED: COMMON REQUIRED: 18 UNITS X 80 SF X 1.33 = 1,916 SF
PRIVATE REQUIRED: 2,396 SF AT ROOF DECK

TOTAL : 4,392 SF
UNIT 202 = 618 SF
UNIT 203 = 948 SF

BUILDING AREA CALCULATIONS:

RESIDENTIAL:	23,865 SF
RETAIL/OFFICE:	2,525 SF
PARKING:	190 SF
COMMON:	7,208 SF
TOTAL GROSS SQUARE FEET:	39,771 SQ. FT.

** PLANNING CODE SECTION 102.3 DEFINITION EXCLUDES FROM GROSS AREA
CALCULATIONS: ROOF LEVEL STAIR, ELEVATOR AND MECHANICAL PENTHOUSES,
ELEVATOR SHAFTS AND LIFE SUPPORT SYSTEMS SERVING EXCLUSIVE RESIDENTIAL
UNITS, PRIVATE GARAGES, PRIVATE GARAGES, PRIVATE GARAGES, PRIVATE
ROOF OR IN REAR YARD.

DRAWING INDEX

A1.0	SITE PLAN, DRAWING INDEX, PROJECT DESCRIPTION
A2.0	FLOOR PLANS
A2.1	FLOOR PLANS
A2.2	ROOF PLANS
A3.0	ELEVATIONS
A3.1	ELEVATIONS
A4.0	SECTIONS

Site Plans
General Notes

Scale: 1/8" = 1'-0"

A1.0

SITE PLAN

SCALE: 1/8" = 1'-0"

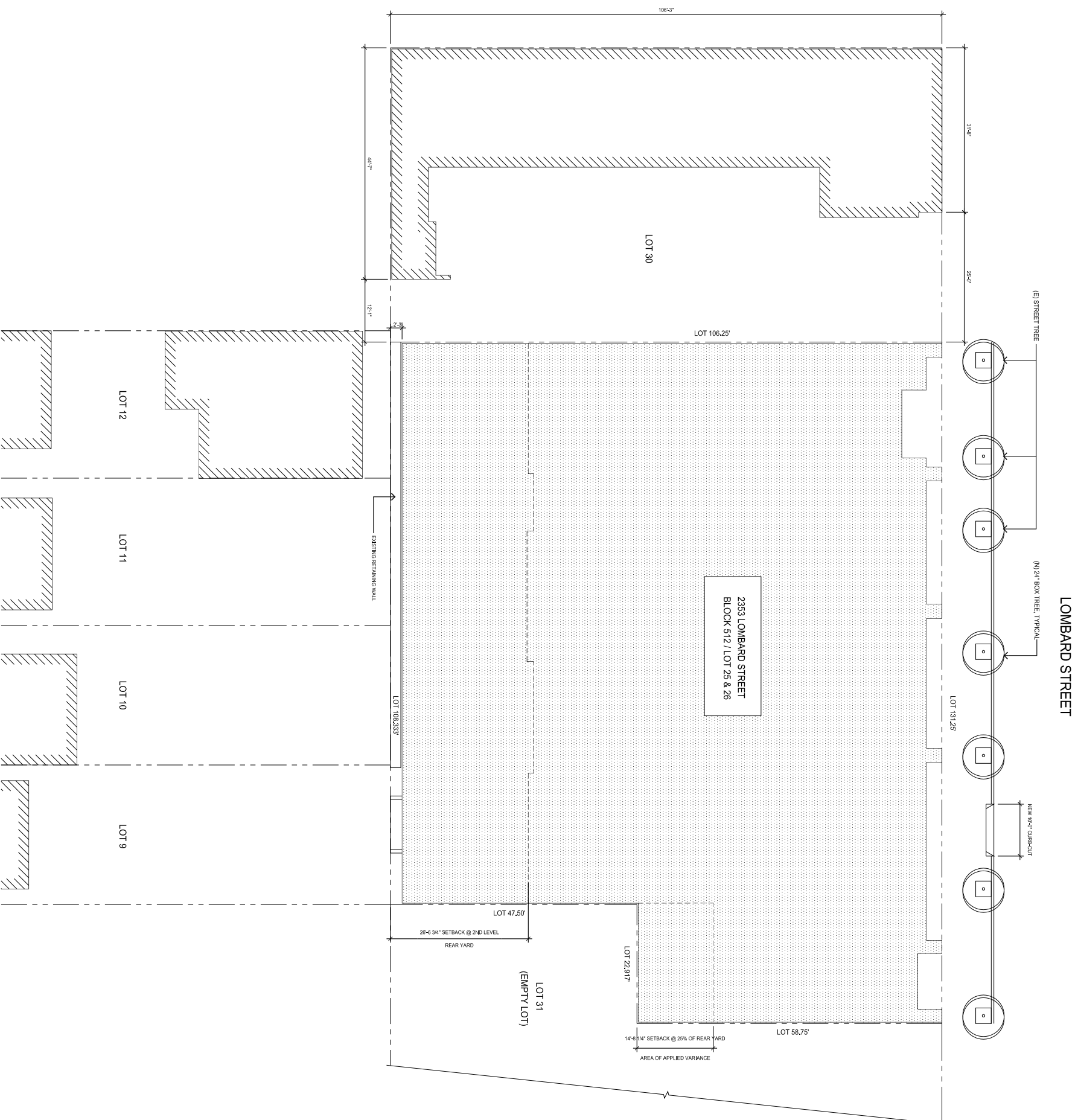

LOMBARD STREET

(E) STREET TREE

(N) 24" BOX TREE TYPICAL

NEW 10'-0" CURB/CUT

LOT 131.25'

31'-4"

25'-0"

106'-3"

LOT 30

LOT 106.25'

LOT 11

LOT 10

LOT 9

LOT 47.50'

LOT 22.917'

LOT 58.75'

LOT 22.917'

LOT 31 (EMPTY LOT)

LOT 106.25'

2353 LOMBARD STREET
BLOCK 512 / LOT 25 & 26

12'-1"

44'-7"

2'-3"

EXISTING RETAINING WALL

REAR YARD

26'-6 3/4" SETBACK @ 2ND LEVEL

AREA OF APPLIED VARIANCE

14'-0" SETBACK @ 25% OF REAR YARD

106'-3"

106'-3"

106'-3"

106'-3"

106'-3"

106'-3"

106'-3"

106'-3"

106'-3"

106'-3"

106'-3"

106'-3"

106'-3"

106'-3"

106'-3"

106'-3"

106'-3"

106'-3"

106'-3"

106'-3"

106'-3"

106'-3"

2353 Lombard Street

San Francisco • California

**GARY
E E
A I A**

GARY GEE ARCHITECTS, INC.
98 Brady Street, 4th
San Francisco, CA 94103
Tel: 415.398.8877
Fax: 415.398.8879

CONTRACT NO. 2017-001 GARY GEE ARCHITECTS, INC.
DRAWINGS NO. 2017-001-01, 02, 03, 04, 05, 06, 07, 08, 09, 10, 11, 12, 13, 14, 15, 16, 17, 18, 19, 20, 21, 22, 23, 24, 25, 26, 27, 28, 29, 30, 31, 32, 33, 34, 35, 36, 37, 38, 39, 40, 41, 42, 43, 44, 45, 46, 47, 48, 49, 50, 51, 52, 53, 54, 55, 56, 57, 58, 59, 60, 61, 62, 63, 64, 65, 66, 67, 68, 69, 70, 71, 72, 73, 74, 75, 76, 77, 78, 79, 80, 81, 82, 83, 84, 85, 86, 87, 88, 89, 90, 91, 92, 93, 94, 95, 96, 97, 98, 99, 100, 101, 102, 103, 104, 105, 106, 107, 108, 109, 110, 111, 112, 113, 114, 115, 116, 117, 118, 119, 120, 121, 122, 123, 124, 125, 126, 127, 128, 129, 130, 131, 132, 133, 134, 135, 136, 137, 138, 139, 140, 141, 142, 143, 144, 145, 146, 147, 148, 149, 150, 151, 152, 153, 154, 155, 156, 157, 158, 159, 160, 161, 162, 163, 164, 165, 166, 167, 168, 169, 170, 171, 172, 173, 174, 175, 176, 177, 178, 179, 180, 181, 182, 183, 184, 185, 186, 187, 188, 189, 190, 191, 192, 193, 194, 195, 196, 197, 198, 199, 200, 201, 202, 203, 204, 205, 206, 207, 208, 209, 210, 211, 212, 213, 214, 215, 216, 217, 218, 219, 220, 221, 222, 223, 224, 225, 226, 227, 228, 229, 230, 231, 232, 233, 234, 235, 236, 237, 238, 239, 240, 241, 242, 243, 244, 245, 246, 247, 248, 249, 250, 251, 252, 253, 254, 255, 256, 257, 258, 259, 260, 261, 262, 263, 264, 265, 266, 267, 268, 269, 270, 271, 272, 273, 274, 275, 276, 277, 278, 279, 280, 281, 282, 283, 284, 285, 286, 287, 288, 289, 290, 291, 292, 293, 294, 295, 296, 297, 298, 299, 300, 301, 302, 303, 304, 305, 306, 307, 308, 309, 310, 311, 312, 313, 314, 315, 316, 317, 318, 319, 320, 321, 322, 323, 324, 325, 326, 327, 328, 329, 330, 331, 332, 333, 334, 335, 336, 337, 338, 339, 340, 341, 342, 343, 344, 345, 346, 347, 348, 349, 350, 351, 352, 353, 354, 355, 356, 357, 358, 359, 360, 361, 362, 363, 364, 365, 366, 367, 368, 369, 370, 371, 372, 373, 374, 375, 376, 377, 378, 379, 380, 381, 382, 383, 384, 385, 386, 387, 388, 389, 390, 391, 392, 393, 394, 395, 396, 397, 398, 399, 400, 401, 402, 403, 404, 405, 406, 407, 408, 409, 410, 411, 412, 413, 414, 415, 416, 417, 418, 419, 420, 421, 422, 423, 424, 425, 426, 427, 428, 429, 430, 431, 432, 433, 434, 435, 436, 437, 438, 439, 440, 441, 442, 443, 444, 445, 446, 447, 448, 449, 450, 451, 452, 453, 454, 455, 456, 457, 458, 459, 460, 461, 462, 463, 464, 465, 466, 467, 468, 469, 470, 471, 472, 473, 474, 475, 476, 477, 478, 479, 480, 481, 482, 483, 484, 485, 486, 487, 488, 489, 490, 491, 492, 493, 494, 495, 496, 497, 498, 499, 500, 501, 502, 503, 504, 505, 506, 507, 508, 509, 510, 511, 512, 513, 514, 515, 516, 517, 518, 519, 520, 521, 522, 523, 524, 525, 526, 527, 528, 529, 530, 531, 532, 533, 534, 535, 536, 537, 538, 539, 540, 541, 542, 543, 544, 545, 546, 547, 548, 549, 550, 551, 552, 553, 554, 555, 556, 557, 558, 559, 560, 561, 562, 563, 564, 565, 566, 567, 568, 569, 570, 571, 572, 573, 574, 575, 576, 577, 578, 579, 580, 581, 582, 583, 584, 585, 586, 587, 588, 589, 590, 591, 592, 593, 594, 595, 596, 597, 598, 599, 600, 601, 602, 603, 604, 605, 606, 607, 608, 609, 610, 611, 612, 613, 614, 615, 616, 617, 618, 619, 620, 621, 622, 623, 624, 625, 626, 627, 628, 629, 630, 631, 632, 633, 634, 635, 636, 637, 638, 639, 640, 641, 642, 643, 644, 645, 646, 647, 648, 649, 650, 651, 652, 653, 654, 655, 656, 657, 658, 659, 660, 661, 662, 663, 664, 665, 666, 667, 668, 669, 670, 671, 672, 673, 674, 675, 676, 677, 678, 679, 680, 681, 682, 683, 684, 685, 686, 687, 688, 689, 690, 691, 692, 693, 694, 695, 696, 697, 698, 699, 700, 701, 702, 703, 704, 705, 706, 707, 708, 709, 710, 711, 712, 713, 714, 715, 716, 717, 718, 719, 720, 721, 722, 723, 724, 725, 726, 727, 728, 729, 730, 731, 732, 733, 734, 735, 736, 737, 738, 739, 740, 741, 742, 743, 744, 745, 746, 747, 748, 749, 750, 751, 752, 753, 754, 755, 756, 757, 758, 759, 760, 761, 762, 763, 764, 765, 766, 767, 768, 769, 770, 771, 772, 773, 774, 775, 776, 777, 778, 779, 780, 781, 782, 783, 784, 785, 786, 787, 788, 789, 790, 791, 792, 793, 794, 795, 796, 797, 798, 799, 800, 801, 802, 803, 804, 805, 806, 807, 808, 809, 810, 811, 812, 813, 814, 815, 816, 817, 818, 819, 820, 821, 822, 823, 824, 825, 826, 827, 828, 829, 830, 831, 832, 833, 834, 835, 836, 837, 838, 839, 840, 841, 842, 843, 844, 845, 846, 847, 848, 849, 850, 851, 852, 853, 854, 855, 856, 857, 858, 859, 860, 861, 862, 863, 864, 865, 866, 867, 868, 869, 870, 871, 872, 873, 874, 875, 876, 877, 878, 879, 880, 881, 882, 883, 884, 885, 886, 887, 888, 889, 890, 891, 892, 893, 894, 895, 896, 897, 898, 899, 900, 901, 902, 903, 904, 905, 906, 907, 908, 909, 910, 911, 912, 913, 914, 915, 916, 917, 918, 919, 920, 921, 922, 923, 924, 925, 926, 927, 928, 929, 930, 931, 932, 933, 934, 935, 936, 937, 938, 939, 940, 941, 942, 943, 944, 945, 946, 947, 948, 949, 950, 951, 952, 953, 954, 955, 956, 957, 958, 959, 960, 961, 962, 963, 964, 965, 966, 967, 968, 969, 970, 971, 972, 973, 974, 975, 976, 977, 978, 979, 980, 981, 982, 983, 984, 985, 986, 987, 988, 989, 990, 991, 992, 993, 994, 995, 996, 997, 998, 999, 1000.

Project No. 12-026 Date 12.04.12

Revisions

No.	Revised	Date
1	ISSUED FOR REVIEW	12.21.12
2	ISSUED FOR REVIEW	12.24.12
3	ISSUED FOR REVIEW	01.07.13
4	ISSUED FOR REVIEW	01.26.13
5	REVISION FOR CU	02.15.13
6	REVISION FOR CU	04.15.13
7	REVISION	07.26.13
8	REVISION	07.16.13
9	REVISION	08.26.13
10	REVISION	08.16.13
11	REVISION FOR PERMITS	10.26.13
12	FOR REVISION	11.26.13

Floor Plans

Scale: 1/8" = 1'-0"

A2.0

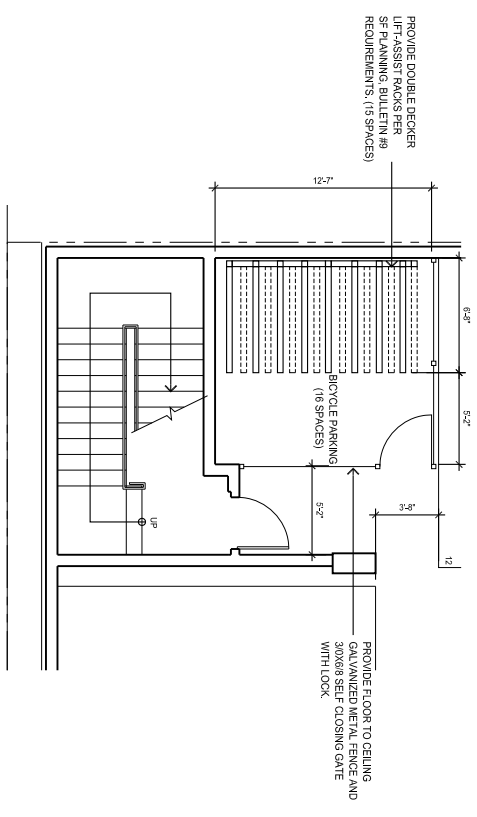

GROUND FLOOR BICYCLE PARKING PLAN

SCALE: 1/4" = 1'-0"

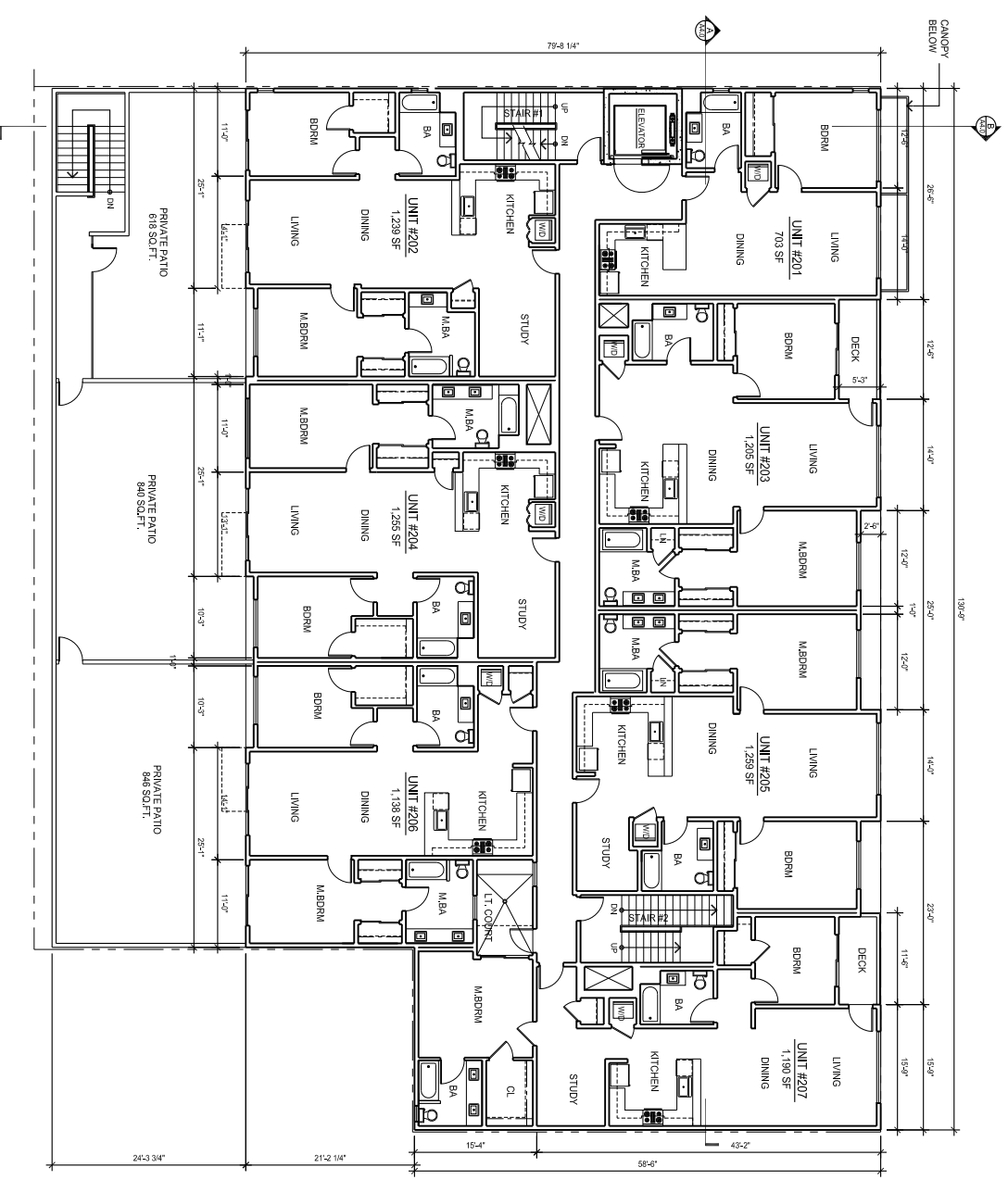

SECOND FLOOR LEVEL PLAN

SCALE: 1/8" = 1'-0"

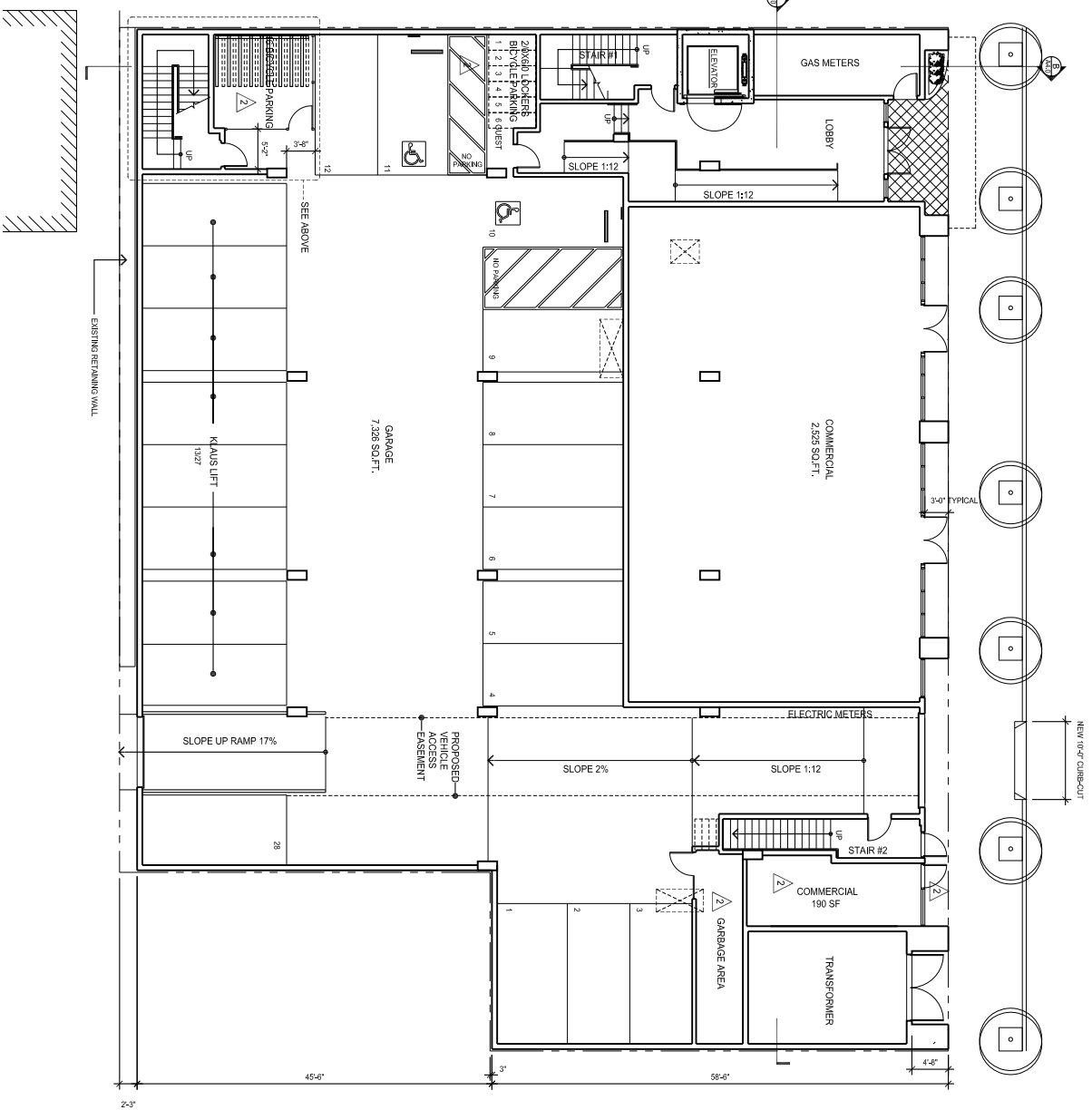

GROUND FLOOR LEVEL PLAN

SCALE: 1/8" = 1'-0"

2353 Lombard Street

San Francisco • California

**GARY
E E E
A I A**

GARY GEE ARCHITECTS, INC.
98 Brady Street, 4th
San Francisco, CA 94103
Tel: 415.398.8777
Fax: 415.398.8779

© 2014 GARY GEE ARCHITECTS, INC. ALL RIGHTS RESERVED. THIS DOCUMENT IS THE PROPERTY OF GARY GEE ARCHITECTS, INC. AND IS NOT TO BE REPRODUCED, COPIED, OR TRANSMITTED IN ANY FORM OR BY ANY MEANS, ELECTRONIC OR MECHANICAL, INCLUDING PHOTOCOPYING, RECORDING, OR BY ANY INFORMATION STORAGE AND RETRIEVAL SYSTEM, WITHOUT THE WRITTEN PERMISSION OF GARY GEE ARCHITECTS, INC.

Project No. **12-026** Date **12.04.12**

Revisions

No.	Revised
	Issue / Date
	ISSUED FOR REVIEW 12.11.12
	ISSUED FOR REVIEW 12.24.12
	ISSUED FOR REVIEW 01.07.13
	ISSUED FOR REVIEW 01.28.13
	ISSUED FOR CU 02.14.13
	REVISION FOR CU 02.15.13
	REVISION 04.15.13
	REVISION 07.26.13
	REVISION 07.16.13
	REVISION 08.16.13
	REVISION 08.16.13
	REVISION 10.26.13
	FOR REPERM 11.26.13

Floor Plans

Scale: 1/8" = 1'-0"

A2.1

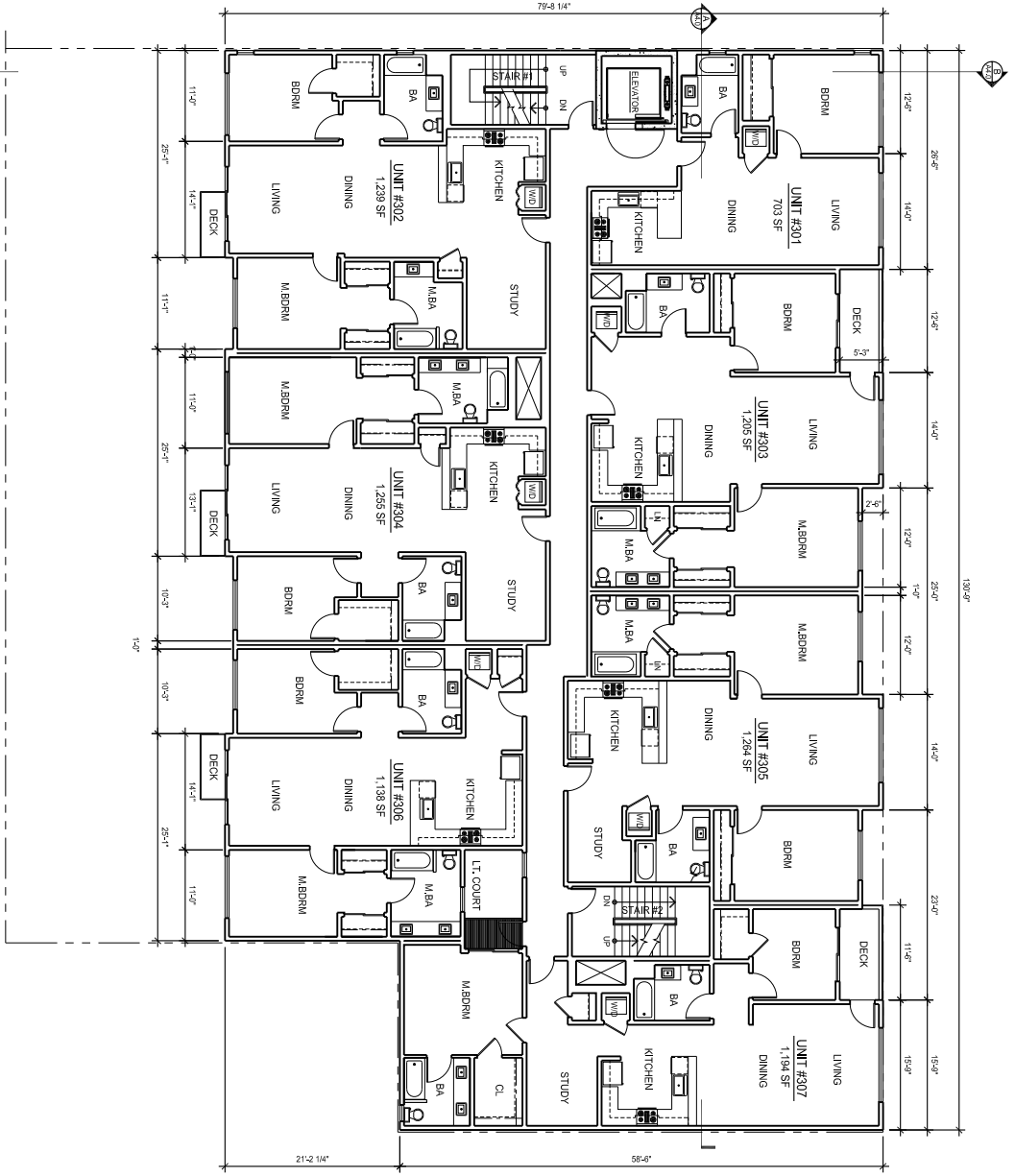
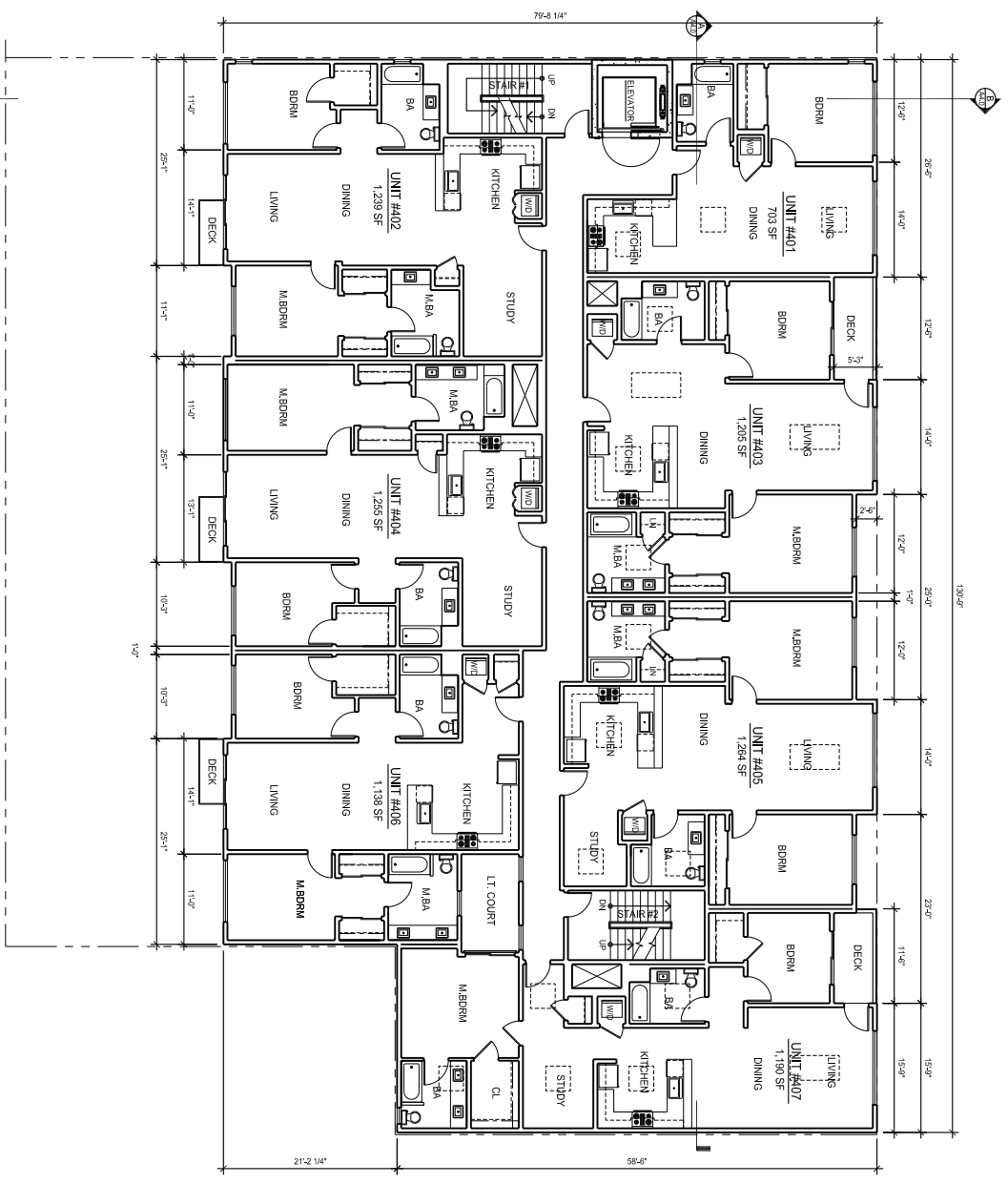

2353 Lombard Street

San Francisco • California

**GARY
E E A I I A**

GARY GEE ARCHITECTS, INC.
98 Brady Street, 4th
San Francisco, CA 94103
Tel: 415.398.8877
Fax: 415.398.8879

CONTRACT DOCUMENTS ARE THE PROPERTY OF GARY GEE ARCHITECTS, INC. AND SHALL REMAIN THE PROPERTY OF THE ARCHITECT. NO PART OF THESE DOCUMENTS ARE TO BE REPRODUCED OR TRANSMITTED IN ANY FORM OR BY ANY MEANS, ELECTRONIC OR MECHANICAL, INCLUDING PHOTOCOPYING, RECORDING, OR BY ANY INFORMATION STORAGE AND RETRIEVAL SYSTEM, WITHOUT THE WRITTEN PERMISSION OF GARY GEE ARCHITECTS, INC.

Project No. **12-026** Date **12.04.12**

Revisions

No.	Revised Date	Description
		ISSUED FOR REVIEW
	12.11.12	ISSUED FOR REVIEW
	12.24.12	ISSUED FOR REVIEW
	01.07.13	ISSUED FOR REVIEW
	01.28.13	ISSUED FOR REVIEW
	01.14.13	REVISION FOR CU
	02.15.13	REVISION FOR CU
	04.15.13	REVISION FOR CU
	07.26.13	REVISION
	07.16.13	REVISION
	08.05.13	REVISION
	08.16.13	REVISION
	09.25.13	REVISION
	10.26.13	REVISION PER PLANNING
	11.26.13	FOR NEIGHBOR

Elevations

Scale: 1/8" = 1'-0"

A3.0

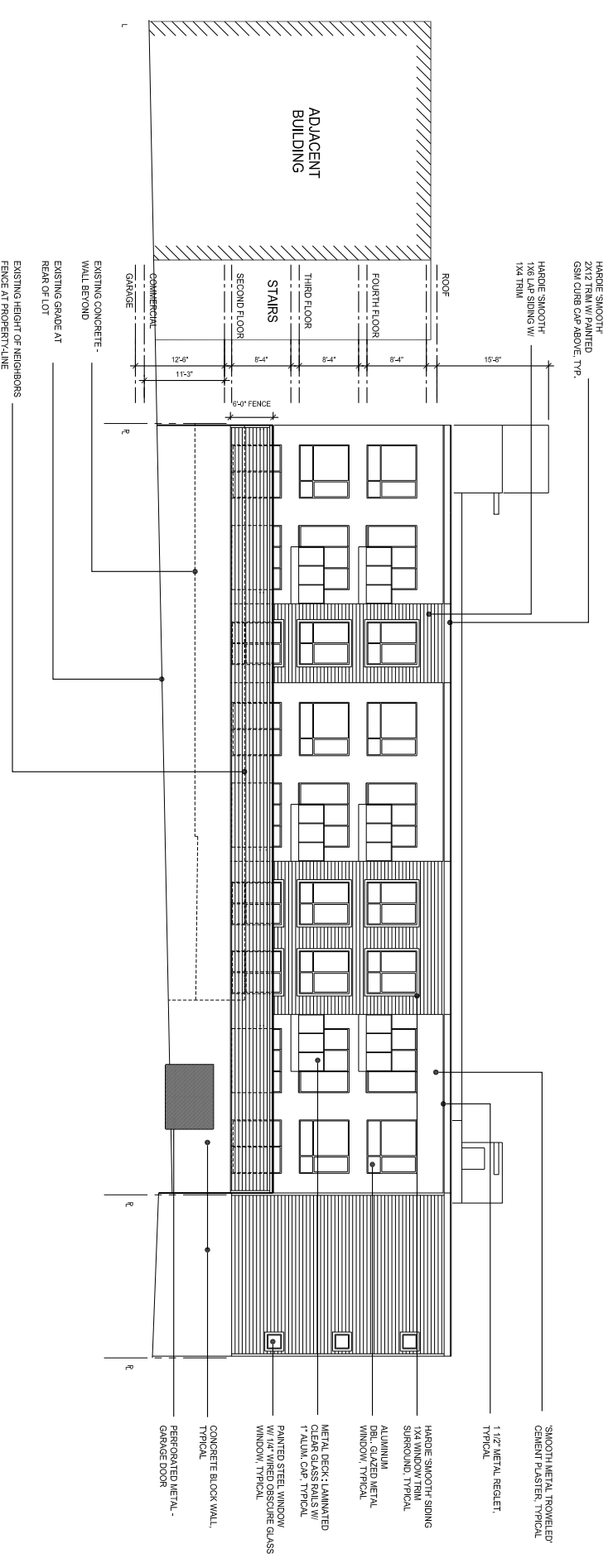

SOUTH ELEVATION

SCALE: 1/8" = 1'-0"



NORTH ELEVATION

SCALE: 1/8" = 1'-0"

DETAILS: 700R RECESSED FIXED AND PROJECTED (AT LOMBARD STREET FACADE)



DETAIL 41,42

BONELLI WINDOWS & DOORS
2700 SERIES FIXED RECESSED NAIL FIN WINDOW

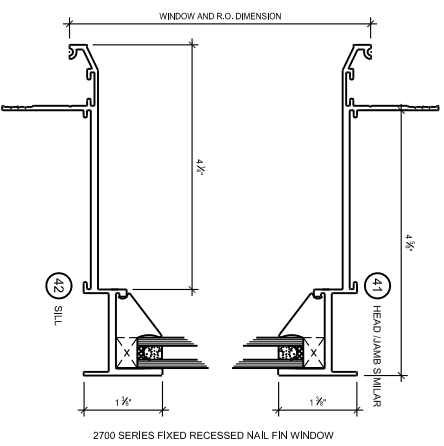

DETAIL 43,44

BONELLI WINDOWS & DOORS
700R SERIES CASEMENT AND AWNING RECESSED NAIL FIN WINDOW

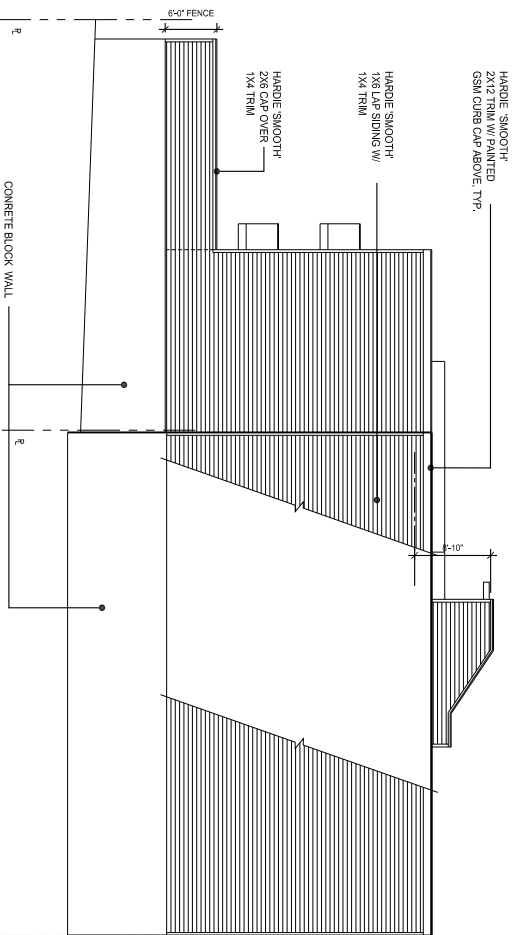
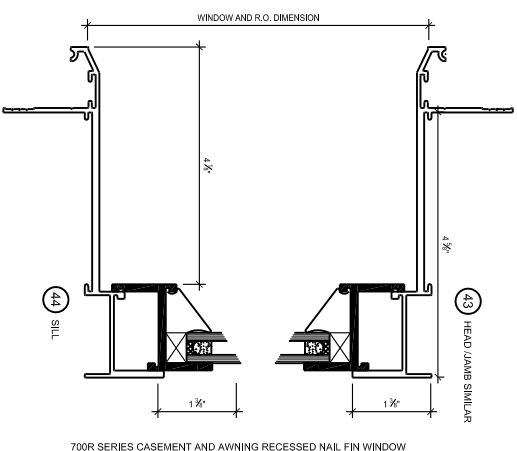

EAST ELEVATION

SCALE: 1/8" = 1'-0"

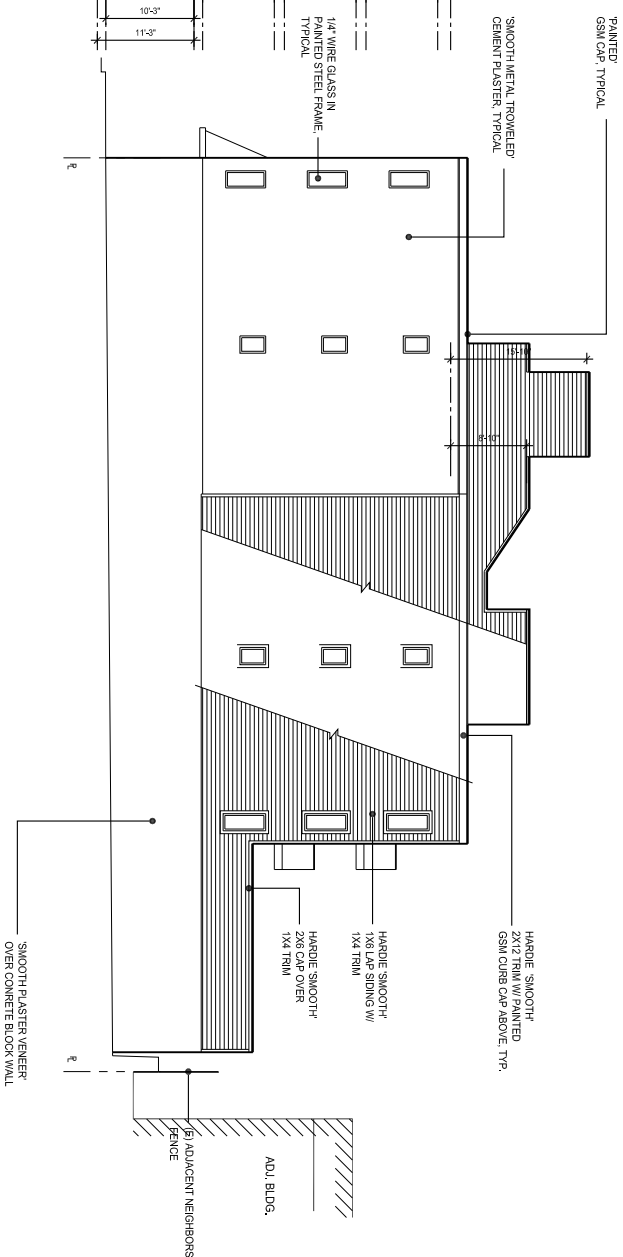
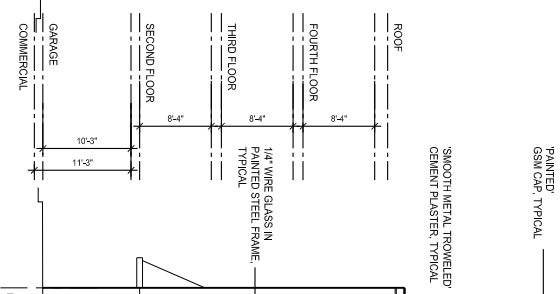

WEST ELEVATION

SCALE: 1/8" = 1'-0"

2353
Lombard
Street

San Francisco • California

**GARY
E E E
A I A**

GARY GEE ARCHITECTS, INC.
98 Brady Street, 4th
San Francisco, CA 94103
Tel: 415.398.8879
Fax: 415.398.8879

GET READY TO MEET THE NEW GARY GEE ARCHITECTS, INC.
REBRAND AND REORGANIZATION. AS
A RESULT OF OUR REORGANIZATION, WE
ARE INTRODUCING A NEW ARCHITECTURAL
FIRM TO THE MARKET. THE NEW FIRM IS
THE GARY GEE ARCHITECTS, INC. AND
IS A 100% OWNED AND OPERATED
CORPORATION. THE NEW FIRM IS
REBRANDING AND REORGANIZING THE
EXISTING ARCHITECTURAL FIRM OF
GARY GEE ARCHITECTS, INC.

Project No. **12,026** Date **12.04.12**

Revisions

No.	Revised Date
ISSUED FOR REVIEW	12.11.12
ISSUED FOR REVIEW	12.24.12
ISSUED FOR REVIEW	01.07.13
ISSUED FOR REVIEW	01.28.13
ISSUED FOR CU	02.14.13
REVISION FOR CU	04.15.13
REVISION	07.26.13
REVISION	07.26.13
REVISION	08.16.13
REVISION	08.26.13
REVISION FOR PLANNING FOR NEIGHBORS	10.26.13
FOR NEIGHBORS	11.26.13

Elevations

Scale: 1/8" = 1'-0"

A3.1

Affidavit for Compliance with the Inclusionary Affordable Housing Program: Planning Code Section 415

April 30, 2013
Date

I, Howard Squires, President, do hereby declare as follows:
Realty Equities, Inc.

a. The subject property is located at (address and block/lot):

2353 Lombard St. San Francisco, CA
Address

512/025 & 512/026
Block / Lot

b. The proposed project at the above address is subject to the Inclusionary Affordable Housing Program, Planning Code Section 415 et seq.

The Planning Case Number and/or Building Permit Number is:

#2009.1177C

Planning Case Number

Building Permit Number

This project requires the following approval:

Planning Commission approval (e.g. Conditional Use Authorization, Large Project Authorization)

This project is principally permitted.

The Current Planner assigned to my project within the Planning Department is:

Sharon Lai

Planner Name

Is this project within the Eastern Neighborhoods Plan Area?

Yes (if yes, please indicate Tier) _____

No

This project is exempt from the Inclusionary Affordable Housing Program because:

This project uses California Debt Limit Allocation Committee (CDLAC) funding.

This project is 100% affordable.

c. This project will comply with the Inclusionary Affordable Housing Program by:

Payment of the Affordable Housing Fee prior to the first site or building permit issuance (Planning Code Section 415.5).

On-site or Off-site Affordable Housing Alternative (Planning Code Sections 415.6 and 416.7).

d. If the project will comply with the Inclusionary Affordable Housing Program through an **On-site or Off-site Affordable Housing Alternative**, please fill out the following regarding how the project is eligible for an alternative and the accompanying unit mix tables on page 4.

- Ownership.** All affordable housing units will be sold as ownership units and will remain as ownership units for the life of the project.
- Rental.** Exemption from Costa Hawkins Rental Housing Act.² The Project Sponsor has demonstrated to the Department that the affordable units are not subject to the Costa Hawkins Rental Housing Act, under the exception provided in Civil Code Sections 1954.50 through one of the following:
 - Direct financial contribution from a public entity.
 - Development or density bonus or other public form of assistance.
 - Development Agreement with the City. The Project Sponsor has entered into or has applied to enter into a Development Agreement with the City and County of San Francisco pursuant to Chapter 56 of the San Francisco Administrative Code and, as part of that Agreement, is receiving a direct financial contribution, development or density bonus, or other form of public assistance.

e. The Project Sponsor acknowledges that failure to sell the affordable units as ownership units or to eliminate the on-site or off-site affordable ownership-only units at any time will require the Project Sponsor to:

- (1) Inform the Planning Department and the Mayor's Office of Housing and, if applicable, fill out a new affidavit;
- (2) Record a new Notice of Special Restrictions; and
- (3) Pay the Affordable Housing Fee plus applicable interest (using the fee schedule in place at the time that the units are converted from ownership to rental units) and any applicable penalties by law.

f. The Project Sponsor must pay the Affordable Housing Fee in full sum to the Development Fee Collection Unit at the Department of Building Inspection for use by the Mayor's Office of Housing prior to the issuance of the first construction document, with an option for the Project Sponsor to defer a portion of the payment to prior to issuance of the first certificate of occupancy upon agreeing to pay a deferral surcharge that would be deposited into the Citywide Affordable Housing Fund in accordance with Section 107A.13.3 of the San Francisco Building Code.

g. I am a duly authorized officer or owner of the subject property.

I declare under penalty of perjury under the laws of the State of California that the foregoing is true and correct. Executed on this day in:

San Francisco, California
Location

April 30, 2013
Date

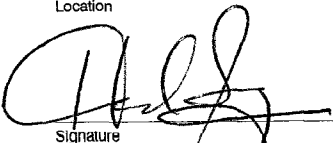
Signature

HOWARD SQUIRES, PRESIDENT
Name (Print), Title
REALTY EQUITIES, INC.

cc: Mayor's Office of Housing
Planning Department Case Docket
Historic File, if applicable
Assessor's Office, if applicable

415/233-2812
Contact Phone Number

Unit Mix Tables

NUMBER OF ALL UNITS IN PRINCIPAL PROJECT:					
Total Number of Units	SRO	Studios	One-Bedroom Units	Two-Bedroom Units	Three-Bedroom Units
21	—	—	3	18	—

If you selected an On-site or Off-Site Alternative, please fill out the applicable section below:

- On-site Affordable Housing Alternative (Charter Section 16.110 (g) and Planning Code Section 415.6): calculated at 12% of the unit total.

NUMBER OF AFFORDABLE UNITS TO BE LOCATED ON-SITE					
Total Affordable Units	SRO	Studios	One-Bedroom Units	Two-Bedroom Units	Three-Bedroom Units

- Off-site Affordable Housing Alternative (Planning Code Section 415.7): calculated at 20% of the unit total.

NUMBER OF AFFORDABLE UNITS TO BE LOCATED OFF-SITE					
Total Affordable Units	SRO	Studios	One-Bedroom Units	Two-Bedroom Units	Three-Bedroom Units

Area of Dwellings in Principal Project (in sq. feet)	Off-Site Project Address:				
Area of Dwellings in Off-Site Project (in sq. feet)					
Off-Site Block/Lot(s)	Motion No. (if applicable)			Number of Market-Rate Units in the Off-site Project	

- Combination of payment of a fee, on-site affordable units, or off-site affordable units with the following distribution:

Indicate what percent of each option would be implemented (from 0% to 99%) and the number of on-site and/or off-site below market rate units for rent and/or for sale.

1. Fee _____ % of affordable housing requirement.
2. On-Site _____ % of affordable housing requirement.

NUMBER OF AFFORDABLE UNITS TO BE LOCATED ON-SITE					
Total Affordable Units	SRO	Studios	One-Bedroom Units	Two-Bedroom Units	Three-Bedroom Units

3. Off-Site _____ % of affordable housing requirement.

NUMBER OF AFFORDABLE UNITS TO BE LOCATED OFF-SITE					
Total Affordable Units	SRO	Studios	One-Bedroom Units	Two-Bedroom Units	Three-Bedroom Units

Area of Dwellings in Principal Project (in sq. feet)	Off-Site Project Address:				
Area of Dwellings in Off-Site Project (in sq. feet)					
Off-Site Block/Lot(s)	Motion No. (if applicable)			Number of Market-Rate Units in the Off-site Project	

Affidavit for Compliance with the Inclusionary Affordable Housing Program

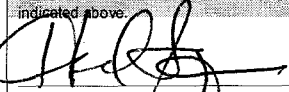
CONTACT INFORMATION AND DECLARATION OF SPONSOR OF PRINCIPAL PROJECT	CONTACT INFORMATION AND DECLARATION OF SPONSOR OF OFF-SITE PROJECT (IF DIFFERENT)
Company Name REALTY EQUITIES, INC	Company Name
Print Name of Contact Person HOWARD SQUIRES	Print Name of Contact Person
Address 2436 GREENWICH ST #5	Address
City, State, Zip SAN FRANCISCO, CA 94123	City, State, Zip
Phone, Fax 415/474-9400	Phone, Fax
Email REISFCA@EARTHLINK.NET	Email
I hereby declare that the information herein is accurate to the best of my knowledge and that I intend to satisfy the requirements of Planning Code Section 415 as indicated above.	I hereby declare that the information herein is accurate to the best of my knowledge and that I intend to satisfy the requirements of Planning Code Section 415 as indicated above.
	Signature
Name (Print), Title HOWARD SQUIRES, PRESIDENT	Name (Print), Title





THE MOMENT
OF THE DAY
BY THE
MOMENT
OF THE DAY

2353

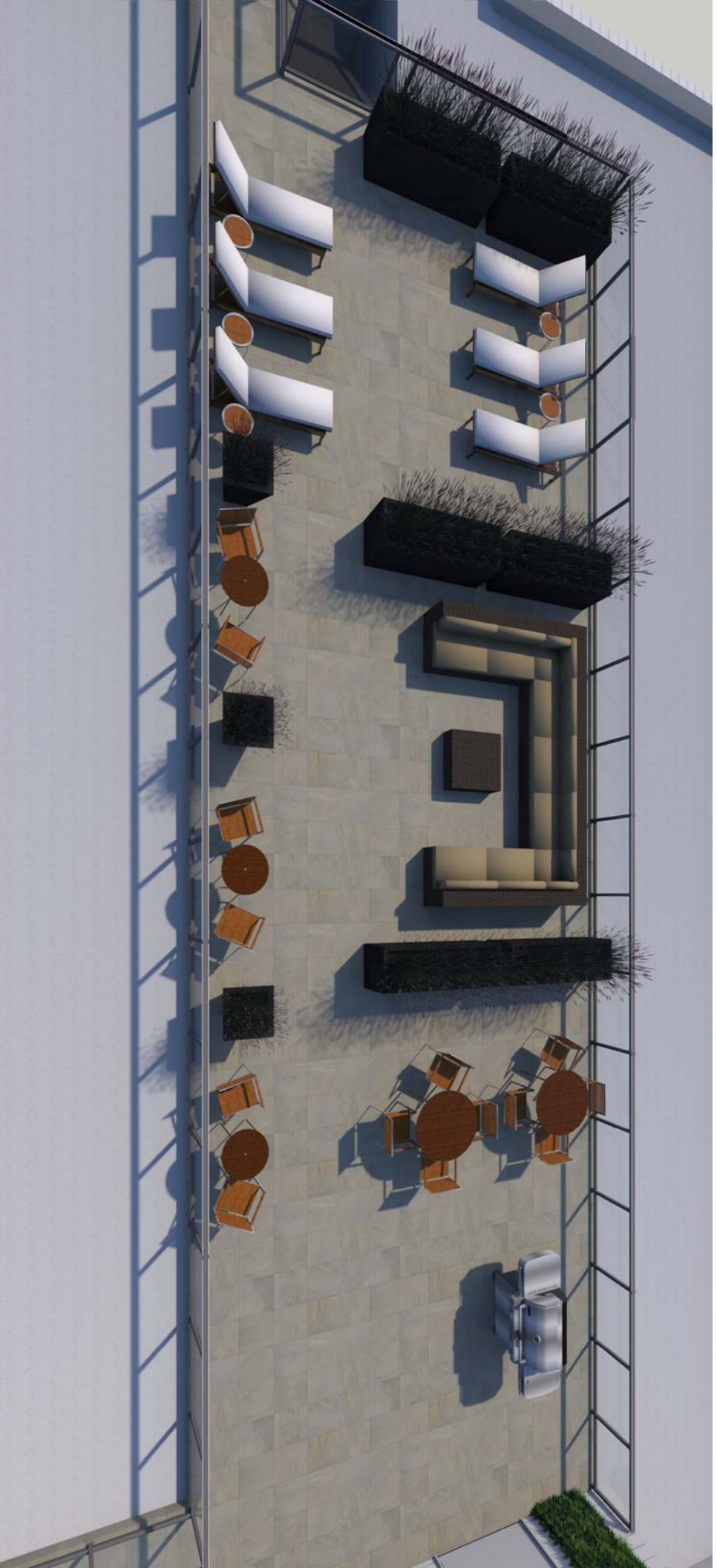

Project Address: 2353 Lombard St.

Roof Deck



Project Address: 2353 Lombard St.

Residential Entry

December 11, 2013

VIA HAND DELIVERY AND EMAIL

Mr. Rodney Fong, President
San Francisco Planning Commission
1650 Mission Street, 4th Floor
San Francisco, CA 94103

Re: 2353 Lombard –Conditional Use Authorization and Variance Application
Planning Dept. Case Number: 2009.1177CV
Planning Commission Hearing Date: December 19, 2013

Dear President Fong and Members of the Commission:

Description of Project

Realty Equities, Inc. is the owner of 2353 Lombard Street (“Property”), located mid-block on the south side of Lombard Street between Pierce and Scott Streets. The proposed project (“Project”) would demolish the existing 23-foot-tall, two story vacant restaurant building with 30 surface parking spaces and construct a new 40 foot-tall, four story, 39,771-square foot, mixed-use building with 21 residential units, 2715 square feet of ground-floor commercial use, and a total of 28 residential surface and individually accessible lift parking spaces. The existing building was constructed in 1973; one existing curb cut would remain. The Project requires Conditional Use authorization for development of a lot with an area greater than 10,000 square feet in size.

Benefits of the Project

- **Increase in Family Housing Supply.** The Project will increase the City’s supply of housing by providing 21 new units, the maximum number of units permitted by the applicable zoning. Three of the 21 units will be 1 bedroom units. The remaining 18 units will have two bedrooms and two bathrooms, some with additional flexible den space. The size of these two bedroom units is well suited for family housing.
- **New Neighborhood-Serving Retail and Commercial Opportunities.** The Project includes 2 separate retail/commercial spaces. One of the retail spaces can be configured to adjust in size to provide greater variety for different types of retail opportunities. The third small space of approximately 190 square feet will hopefully provide Realty Equities with much needed commercial space.
- **Appropriate In-Fill Development Close to Transit and Services.** The Project is located along Lombard Street, a block away from Chestnut Street shopping, and is appropriate for the proposed height, density and uses, close to transit and other services.
- **Bicycle Parking.** The Project provides 22 bicycle parking space.
- **Generation of Construction Jobs.** As a new construction project composed of approximately 39,771 square feet, the Project will create many construction jobs for an estimated 12 to 18 month period.

- **Increased City Revenue.** With 21 new residential units, and over 2,700 square feet of commercial space, the Project will result in increased City tax revenue over the minimal revenue generated by the vacant restaurant building

B. Neighborhood Outreach and Community Support.

Realty Equities, Inc. has been an active member of this neighborhood community for over 75 years. We are members of various neighborhood groups and actively participate in giving back to the community. Realty Equities Inc. has been pro-active in reaching out to neighborhood residents, businesses and organizations through-out the entitlement process. We have sent invitations for neighborhood meetings to neighbors within 300-foot radius of the Property and held 3 general neighborhood meetings. These neighborhood meetings occurred on July 22, 2010, December 28, 2012 and March 13, 2013 and were held at the Property. At the meetings, the neighbors had an opportunity to review the Project with the project architect, ask questions and make comments. Changes to the project have been made to address their concerns. For example, the Variance application to increase the rear yard fence high to 6 feet is at the neighbors' request. Copies of the meetings and sign in sheets are included in the commission packet prepared by planning staff.

C. Desirable In-Fill with 21 New Residential Units.

The Project is consistent with the San Francisco General Plan and with applicable zoning designations. The site is located within a Moderate-Scale Neighborhood Commercial zoning district where the proposed density of development and uses would be permitted. NC-3 district has a residential density of one unit per 600 square feet of lot area. The Project would construct 21 residential units. The usable open space requirement is 80 square feet per unit, if private, and 100 square feet, if common. The Project would provide approximately 2516 common space as a roof deck and additional private open space for a total of 4,552 square feet. The proposed Project provides an ideal mix of uses that are compatible with and beneficial to the neighborhood and a more appropriate use than the existing free standing restaurant. Pursuant to current zoning, the Project appropriately provides residential uses above neighborhood-serving ground floor uses and close to other existing residential and commercial uses, as well as transit and other services.

The Lombard Street ground floor façade is reserved for the residential lobby, retail space, and utilities. A single residential vehicular garage entrance/exit will be accessed from Lombard. The on-grade parking will provide 28 residential parking spaces and 22 bicycle parking spaces.

D. Requested Approvals

The Project Sponsor is requesting a Conditional Use authorization pursuant to Planning Code Sections 121 and 303 to demolish a vacant two-story commercial restaurant building and construction of a four-story mixed-use building containing 21 dwelling units, approximately 2,700 square feet of commercial space and 28 residential parking spaces. The Project proposes to merge two lots resulting in a lot size in excess of 10,000 square feet.

The Project requires a rear yard modification pursuant to Planning Code section 134 (Case No.2009.1177V). The irregularly shaped lot contains a section with a shorter lot depth at the southeast corner of the lot. This section has a required rear yard of 15 feet for approximately 23 feet of the lot width, but no rear yard is provided in this section. Also included in this variance application is a request for a 6 foot high rear screen at the second level rear deck. The 6 foot high screen is to create privacy as requested by the adjacent rear yard neighbors on Greenwich Street.

E. Conclusion.

We are very excited about the positive changes our project will bring to the Lombard corridor and to our neighborhood. Our team has worked very hard on this project and is very proud of the result. I hope you find it as pleasing as we do and that it receives your support.

We look forward to presenting the Project to you on December 19, 2013.

Very truly yours,

Realty Equities, Inc.

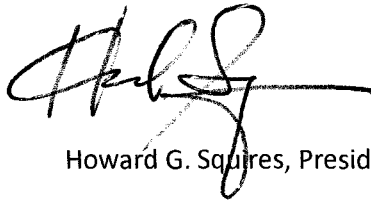
A handwritten signature in black ink, appearing to read 'Howard G. Squires', with a long horizontal line extending to the right.

Howard G. Squires, President

Cc: Commissioner Cindy Wu
Commissioner Michael Antonini
Commissioner Gwyneth Borden
Commissioner Rich Hillis
Commissioner Kathrin Moore
Commissioner Hisashi Sugaya
John Rahaim, Planning Director
Scott Sanchez, Zoning Administrator
Jonas P. Ionin, Commission Secretary
Sharon Lai, Project Planner
Gary Gee, Gary Gee Architects

From: Howard Squires
To: tabas4
Cc: Tom Harrison; Ann Dykstra; Sharon (CPC) Lai
Bcc: Gary Gee; reisfca
Date: 11/26/2013 4:38:57 PM
Subject: FW: Re: 2353 Lombard Finalized Plans

Hi Connie,

Our structural engineers, Double D Engineering visited the site last week to evaluate the rear property retaining wall. This is the wall that adjoins both of our properties and is located at the south property line of 2353 Lombard. Don David, principal of the firm, advised that we would be able to pour new footings for the parking garage south wall against the existing retaining wall so as to not disturb your rear yard or the rear yards of any other adjacent neighbors. This would be done by digging footings limited in section widths of 8-12 feet to minimize any potential impacts on the existing retaining wall. This process would be performed running from east to west until the new footings are complete.

Regarding the insurance. I contacted our insurance agent Mark Benedetti and he stated the following : **Yes we can name the neighbor on the construction liability policy as additional insured for any property damage or bodily injury caused by the general contractor or subcontractors during project construction.**

Please let me know if you have additional questions.

Best-Howard Squires

Howard Squires
reisfca@earthlink.net
 EarthLink Revolves Around You.

----- Original Message -----

From: [Howard Squires](#)
To: [tabas4](#)
Cc: [Sharon \(CPC\) Lai](#)
Sent: 11/18/2013 11:17:47 AM
Subject: Re: 2353 Lombard Finalized Plans

Hi Connie.

Thanks for your email.

We are planning to keep the retaining wall and use it for formwork to pour the new foundation against it.

Our architect is contacting our structural engineer today to get his opinion on this procedure.

I will be back in touch with you as soon as I hear back from the structural engineer.

I have an email in to our insurance broker regarding you being named as additional insured on the construction insurance policy. I believe I checked on this before and it is not a problem but I want to reconfirm.

Best-Howard

----- Original Message -----

From: [Tabas4](#)

To: reisfca@earthlink.net

Cc: fjoseph1butler@gmail.com; Tom Harrison; bb2250@yahoo.com; aedykstra@aol.com; [patricia vaughey](#); [Sharon \(CPC\) Lai](#)

Sent: 11/16/2013 10:42:31 AM

Subject: Re: 2353 Lombard Finalized Plans

Thanks Howard. We look forward to seeing the plans.

One question. When we last met you mention you were going to look into a structural engineer to verify the lateral and subjacent supports regarding our adjoining properties. you also said you would look into your insurance regarding adding us all as beneficiaries of the insurance policy should any damage occur to our properties. Any reports or updates on these?

Best,

Connie and Eric

Sent from my iPhone with a smile, Connie

On Nov 15, 2013, at 3:34 PM, "Howard Squires" <reisfca@earthlink.net> wrote:

Hi All,

Hope you are doing well.

Attached are the most recent architectural drawings for our mixed use project at 2353 Lombard. We are very excited about the positive changes it will bring to Lombard Street and the neighborhood.

We will provide you with a copy of the color project architectural rendering as soon as it is complete

I am happy to answer any questions you may have about the project. Please don't hesitate to contact me.

Best regards-Howard Squires

Howard Squires

reisfca@earthlink.net

EarthLink Revolves Around You.

<2353Lombard111513Neighbor_A1.0-A4.0.pdf>

From: Howard Squires
To: fjoseph1butler@gmail.com
Date: 5/7/2013 3:03:00 PM
Subject: FW: 2353 Lombard Revised Plans 5/3/13

Howard Squires
reisfca@earthlink.net
EarthLink Revolves Around You.

----- Original Message -----
From: [Howard Squires](#)
To: [Joseph Butler architect](#)
Cc: [Tom Harrison; tabas4; Ann Dykstra](#)
Sent: 5/7/2013 3:58:05 PM
Subject: 2353 Lombard Revised Plans 5/3/13

PDF Plans attached

Howard Squires
reisfca@earthlink.net
EarthLink Revolves Around You.

From: Howard Squires
To: ffjoseph1butler@gmail.com
Cc: tomharrison261@aol.com; bb2250@yahoo.com; tabas4; aedykstra@aol.com; Sharon (CPC) Lai
Date: 5/7/2013 3:53:00 PM
Subject: 2535 Lombard Project 2009.1177C

REALTY EQUITIES, INC.
2436 Greenwich St. #5
San Francisco, Ca 94123
415/474-9400
May 7, 2013
Via Email

Hello All,

Attached are the following as promised at our last neighborhood meeting:

Minutes from our follow up neighborhood meeting on March 13, 2013
Notice of Planning Department Requirements List received March 18, 2013
Revised plans submitted to SF Planning Dept on Friday May 3, 2013 (**sent separately via email due to file size**)
Our Response to SF Planning Requirements list dated May 3, 2013

Regarding items noted during our last neighborhood meeting on March 13, 2013 and not addressed at the meeting:

Item #2 - relative heights of the existing fences. The heights were measured and are now reflected on the South elevation of the plans.

Item #3 - New building rear finishes. The finishes have been enhanced to more closely resemble the building frontage.

Item #4 - East staircase roof penthouse. The stair penthouse is at the minimum height to provide egress and ingress to and from the roof.

Item #6 - Adjacent property owners insurance. Our insurance broker will add the adjacent neighbors to the list of additional insured on our liability policy at the time of construction

Item #7 - The Planning Dept urban design team comments are attached to this email.

Please let me know if you have any questions. I will be pleased to address them with our architect and/or the planning department staff.

Sincerely,

Howard Squires, President
cc: Sharon Lai, SF Planning

Howard Squires
reisfca@earthlink.net
EarthLink Revolves Around You.

2353 LOMBARD NEIGHBORHOOD MEETING
WEDNESDAY, MARCH 13, 2013 7:00PM

<u>NAME</u>	<u>ADDRESS</u>	<u>EMAIL</u>	<u>PHONE</u>
GARY GEE	98 BRADY ST/SF.	ggee@garygee.com	(415) 863-8881
F. Joseph Butler, AIA	324 Chestnut St	fjoseph1butler@gmail.com	
TOM HARRISON	2440 GREENWICH ST	TOMHARRISON@aol.com	(415) 867-5887
Bernard Bauer	2443 Greenwich	bb2250@yahoo.com	
Susanne Stolzenberg	2443 Greenwich		
Connie + Eric Tabas	2444 Greenwich St. SF, CA 94123	Tabas+@aol.com	415-441-7764
Ann Dykstra	2450 Greenwich	aedykstra@aol.com	415-509-3937

2353 LOMBARD STREET NEIGHBORHOOD MEETING

Date: Wednesday, March 13, 2013

DRAFT 1

Time: 7:00pm to 8:15pm

Location: 2353 Lombard existing restaurant building

DISCUSSION ITEMS:

1. Joe Butler expressed concerns over the existing retaining wall at the south property line. The existing rear fences of the adjacent properties are on or against this wall. Gary Gee explained the concrete wall will not be removed and the new ground level parking garage has been pulled away from the south property line so the wall can remain.
2. Joe Butler wanted to know the relative heights of the existing fences. Gary Gee said the fences can be measured along with a site visit to the adjacent south residential structure along this adjoining property line. Gary Gee will contact neighbor to get access and visit this south building and fences.
3. Joe Butler asked for quality finishes along the garage wall facing the neighbors and along the south façade of the building. He suggested considering an integral color for any of the Hardiplank Boards. Neighbors asked if there can be similar materials on the North Elevation be also used on the South Elevation.
4. Joe Butler asked if the east staircase to the roof deck can be open from below the roof line. Gary Gee said he will confirm with the SFFD plan checkers to see what would be an acceptable arrangement for an open staircase.
5. Neighbors asked if the residential units will be condos or rented by the project sponsor. Howard Squires said it was intention to map the units as condos and rent them depending upon the residential market conditions when the project is completed.
6. Joe Butler asked if the adjacent property owners can be named as additional insurers on the construction project insurance policy. Howard Squires said he will check with his attorney and insurance agent.
7. Howard Squires said he was waiting for the Planning Department urban design committee to respond to the design of the building. Once that response is received, reasonable changes will be made and drawings resubmitted to the Planning Department. He agreed to shares those Planning Department comments with the neighbors.

From: ERIC & CONNIE TABAS
To: reisfca@earthlink.net
Date: 2/18/2013 6:31:26 PM
Subject: Re: 2353 lombard

Hi Howard,

I will let everyone know. See you on the 13th.

Thanks for arranging it.

Best,

Connie

-----Original Message-----

From: Howard Squires <reisfca@earthlink.net>
To: ERIC & CONNIE TABAS <tabas4@aol.com>
Sent: Mon, Feb 18, 2013 9:37 am
Subject: Re: 2353 lombard

Hi Connie,

Our architect can meet on Wednesday, 3/13 at 7PM. Hope that will work for everyone.

Best-Howard

----- Original Message -----

From: ERIC & CONNIE TABAS
To: reisfca@earthlink.net
Sent: 2/15/2013 2:29:36 PM
Subject: Re: 2353 lombard

Yes that is correct. I am pasting in the email I sent to you in case this one makes it back to you.
 Let me know if you receive this one.

Best, Connie

Dear Howard,

Happy Valentine's Day. We hope you are doing well.

We would like to take advantage of the opportunity to meet with you and your architect. Since we were unable to attend the December 28th meeting, we would appreciate you inviting your architect to attend this meeting and thereby the two of you could give your presentation about the 2353 Lombard street project to all of us at that time . We are hopeful that you can have this meeting at the restaurant space at 7:00P.M.

In canvassing the group the available dates that we can all make are the following;

2/20, 3/6, 3/12 or 3/13

We look forward to having a fruitful dialogue together. Looking forward to your prompt response.

Sincerely,

Connie and Eric Tabas

415-640-8223 Connie's cell phone

415-441-7764 Home phone

2444 Greenwich Street
Tabas4@aol.com

-----Original Message-----

From: Howard Squires <reisfca@earthlink.net>
To: tabas4 <tabas4@AOL.COM>
Sent: Fri, Feb 15, 2013 2:08 pm
Subject: 2353 lombard

Hi Connie,
The dates a have written down are 2/20, 3/6,3/12 and 3/13 all at 7PM.
Thanks-Howard

Howard Squires
reisfca@earthlink.net
EarthLink Revolves Around You.

From: Howard Squires
To: David.lindsay
Date: 1/24/2013 2:21:02 PM
Subject: 2009.1177C 2353 Lombard

Hi David,
Attached are copies of letters I sent, at your suggestion, to neighbors who were unable to attend our neighborhood notification meeting. The names were obtained from the letter also attached from Dr. Bernard Bauer to me dated December 28, 2012.
The letters were sent to:
Anne Dukstra 2450 Greenwich St.
Thomas Harrison 2438 Greenwich St.
Eric & Connie Tabas 2444 Greenwich St.
David & Lola Safer 3103 Pierce St.

Thanks-Howard

Howard Squires
reisfca@earthlink.net
EarthLink Revolves Around You.

January 24, 2013

Eric and Connie Tabas
2444 Greenwich Street
San Francisco, Ca 94123

Re: 2353 Lombard Street, San Francisco
Mixed Use Development

Dear Dr. and Mrs. Tabas:

I am writing regarding the above noted development plans at the former Art's restaurant located at 2535 Lombard Street. We are very excited about the plans and the many improvements it will bring to the neighborhood.

Dr. Bernard Bauer, a neighbor, has indicated per the attached letter, that you were unable to attend our neighborhood meeting due to a scheduling conflict. We are sorry we were unable to meet with you but would like to extend an invitation to discuss the project at your convenience.

Please feel free to call me at the office or on my mobile, 415/233-2812 if you would like to schedule a meeting or to discuss the project plans on the phone. I look forward to hearing from you.

Sincerely,

Howard Squires, President

January 24, 2013

David and Lola Safer
3103 Pierce Street
San Francisco, Ca 94123

Re: 2353 Lombard Street, San Francisco
Mixed Use Development

Dear Mr. and Mrs. Safer:

I am writing regarding the above noted development plans at the former Art's restaurant located at 2535 Lombard Street. We are very excited about the plans and the many improvements it will bring to the neighborhood.

Dr. Bernard Bauer, a neighbor, has indicated per the attached letter, that you were unable to attend our neighborhood meeting due to a scheduling conflict. We are sorry we were unable to meet with you but would like to extend an invitation to discuss the project at your convenience.

Please feel free to call me at the office or on my mobile, 415/233-2812 if you would like to schedule a meeting or to discuss the project plans on the phone. I look forward to hearing from you.

Sincerely,

Howard Squires, President

January 24, 2013

Thomas Harrison
2438 Greenwich St.
San Francisco, Ca 94123

Re: 2353 Lombard Street, San Francisco
Mixed Use Development

Dear Tom:

I am writing regarding the above noted development plans at the former Art's restaurant located at 2535 Lombard Street. We are very excited about the plans and the many improvements it will bring to the neighborhood.

Dr. Bernard Bauer, a neighbor, has indicated per the attached letter, that you were unable to attend our neighborhood meeting due to a scheduling conflict. We are sorry we were unable to meet with you but would like to extend an invitation to discuss the project at your convenience.

Please feel free to call me at the office or on my mobile, 415/233-2812 if you would like to schedule a meeting or to discuss the project plans on the phone. I look forward to hearing from you.

Sincerely,

Howard Squires, President

January 24, 2013

Anne Dykstra
2450 Greenwich St.
San Francisco, Ca 94123

Re: 2353 Lombard Street, San Francisco
Mixed Use Development

Dear Ms. Dykstra:

I am writing regarding the above noted development plans at the former Art's restaurant located at 2535 Lombard Street. We are very excited about the plans and the many improvements it will bring to the neighborhood.

Dr. Bernard Bauer, a neighbor, has indicated per the attached letter, that you were unable to attend our neighborhood meeting due to a scheduling conflict. We are sorry we were unable to meet with you but would like to extend an invitation to discuss the project at your convenience.

Please feel free to call me at the office or on my mobile, 415/233-2812 if you would like to schedule a meeting or to discuss the project plans on the phone. I look forward to hearing from you.

Sincerely,

Howard Squires, President

BERNARD BAUER, PH.D.
SUSANNE STOLZENBERG, ESQ.
2443 GREENWICH STREET
SAN FRANCISCO, CA 94123
(415) 775-3047

SENT BY FAX

December 28, 2012

To: Mr. Howard Squires
Re: 2353 Lombard Street development

Dear Mr. Squires:

This will confirm that at the Pre-Application Meeting this evening, Friday, 1/28/12 at 6 p.m., you agreed to provide us with a full-size, full set of the plans for the 2353 Lombard Street project on 1/7/13, at our expense.

This will also confirm that you will submit your plans to the Planning Department on 1/15/13.

Finally, this will confirm that we attended the meeting representing not just ourselves but also Anne Dykstra, Thomas Harrison, David and Lola Safer, and Eric and Connie Tabas, all of whose homes abut or are close to your property. They were unable to attend because of when you scheduled this meeting, which is required by the Planning Department in an effort to address neighborhood concerns and avoid the Discretionary Review process. It is obvious that you have no interest in doing so.

If our understanding about (a) receiving of a copy of the plans and (b) the date that you will submit them is incorrect, please let us know immediately by email at bb2250@yahoo.com. (We are faxing this letter because we do not have your email address.)

We will be away from 12/29/12 to 1/6/2013. Please have the plans delivered to us at 2443 Greenwich Street on 1/7/13, also at our expense.

As we told you at the meeting, we are represented by Joseph Breall, Esq., who is copied on this letter. He too was unable to attend the Pre-Application Meeting because of when you scheduled it.

Sincerely,

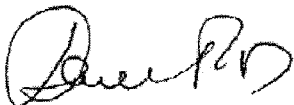

Bernard Bauer, Ph.D.

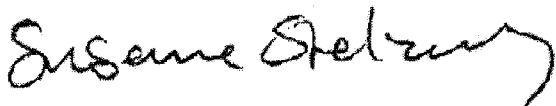

Susanne Stolzenberg, Esq.

cc: Joseph Breall, Esq., Gary Gee, AIA

From: Howard Squires
To: Bernard Bauer
Date: 1/15/2013 2:30:46 PM
Subject: 2353 Lombard Project

Dr. Bauer and Ms. Stolzenberg:

The full size set of plans you requested regarding the proposed project located at 2353 Lombard St. San Francisco was delivered today to your residence located at 2443 Greenwich Street, San Francisco. The plans are a full size duplicate of those submitted today to the planning department and dated revision 1/15/2013. There will be no charge to you for these plans. If you have any question please don't hesitate to contact me.

Sincerely

Howard Squires

Realty Equities, Inc.

cc: David Lindsay, SF Planning

Howard Squires

reisfca@earthlink.net

EarthLink Revolves Around You.

From: Howard Squires
To: BB2443@yahoo.com
Cc: david.lindsay@sfgov.org; Gary Gee
Date: 1/4/2013 5:10:08 PM
Subject: 2353 Lombard Project

Dr. Bauer and Ms. Stolzenberg:

I am in receipt of your letter to me dated December 28, 2012 and faxed to the office of Gary Gee Architects. I am glad to provide you with a full size architectural plan set as we discussed at the project pre-application meeting on December 28, 2012. As soon as they are available from our architect I will have them delivered to your residence located at 2443 Greenwich St., San Francisco, Ca We are in the process of making some minor revisions to the interior spaces and expect the plans to be available no later than February 15, 2013. Please feel to contact me if you have any questions.

Sincerely
Howard Squires, President
Realty Equities, Inc.

Howard Squires
reisfca@earthlink.net
EarthLink Revolves Around You.

Pre-Application Meeting Sign-in Sheet

Meeting Date: DECEMBER 28, 2012
 Meeting Time: 6:00 PM
 Meeting Address: 2353 LOMBARD STREET
 Project Address: 2353 LOMBARD STREET
 Property Owner Name: REALTY EQUITIES, INC.
 Project Sponsor/Representative: GARY GEE

Please print your name below, state your address and/or affiliation with a neighborhood group, and provide your phone number. Providing your name below does not represent support or opposition to the project; it is for documentation purposes only.

	NAME/ORGANIZATION	ADDRESS	PHONE #	EMAIL	SEND PLANS
1.	S. STOLZENBERG	2443 GREENWICH	567-8271		<input type="checkbox"/>
2.	B. BAUER	2443 GREENWICH	567-8271		<input checked="" type="checkbox"/>
3.	GARY GEE	98 BRADY ST	863-8881		<input type="checkbox"/>
4.	HOWARD SQUARES	2436 GREENWICH ^{#5}			<input type="checkbox"/>
5.					<input type="checkbox"/>
6.					<input type="checkbox"/>
7.					<input type="checkbox"/>
8.					<input type="checkbox"/>
9.					<input type="checkbox"/>
10.					<input type="checkbox"/>
11.					<input type="checkbox"/>
12.					<input type="checkbox"/>
13.					<input type="checkbox"/>
14.					<input type="checkbox"/>
15.					<input type="checkbox"/>
16.					<input type="checkbox"/>
17.					<input type="checkbox"/>
18.					<input type="checkbox"/>

Affidavit of Conducting a Pre-Application Meeting, Sign-in Sheet and Issues/Responses submittal

I, HOWARD SQUIRES, do hereby declare as follows:

1. I have conducted a Pre-Application Meeting for the proposed new construction or alteration prior to submitting any entitlement (Building Permit, Variance, Conditional Use, etc.) in accordance with Planning Commission Pre-Application Policy.
2. The meeting was conducted at 2353 LOMBARD ST (location/address) on 12/28/12 (date) from 6 PM (time).
3. I have included the mailing list, meeting initiation, sign-in sheet, issue/response summary, and reduced plans with the entitlement Application. I understand that I am responsible for the accuracy of this information and that erroneous information may lead to suspension or revocation of the permit.
4. I have prepared these materials in good faith and to the best of my ability.

I declare under penalty of perjury under the laws of the State of California that the foregoing is true and correct.

EXECUTED ON THIS DAY, January 15, 2013 IN SAN FRANCISCO.

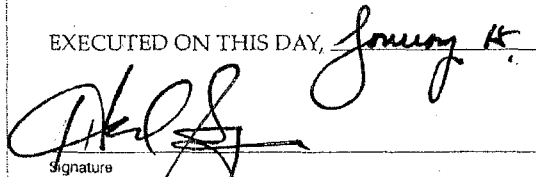

 Signature

HOWARD SQUIRES PRESIDENT
REALTY EQUITIES, INC.
 Name (type or print)

OWNER - PRESIDENT
 Relationship to Project (e.g. Owner, Agent)
 (If Agent, give business name & profession)

2353 LOMBARD
 Project Address

Summary of discussion from the Pre-Application Meeting

Meeting Date: DECEMBER 28, 2012
 Meeting Time: 6:00 PM
 Meeting Address: 2353 LOMBARD STREET
 Project Address: 2353 LOMBARD STREET
 Property Owner Name: READY EQUITIES, INC.
 Project Sponsor/Representative: GARY GEE

Please summarize the questions/comments and your response from the Pre-Application meeting in the space below. Please state if/how the project has been modified in response to any concerns.

Question/Concern #1 by (name of concerned neighbor/neighborhood group): MR. BAYER SAID THE MEETING TIME AND DATE WAS INCONVENIENT FOR THE NEIGHBORS TO ATTEND.

Project Sponsor Response: MR. SQUIRES EXPLAIN HE WANTED TO FILE THE C.U. APPLICATION BEFORE THE END OF THE YEAR, BUT IS NOT SCHEDULED TO FILE ON JANUARY 15, 2013.

Question/Concern #2: MR. BAYER REQUESTED A SET OF PLANS BY MONDAY, JANUARY 7, 2013.

Project Sponsor Response: MR. SQUIRES AGREED TO HAVE PLANS DELIVERED BY THE REQUESTED DATE.

Question/Concern #3: _____

Project Sponsor Response: _____

Question/Concern #4: _____

Project Sponsor Response: _____

Pre-Application Meeting Sign-in Sheet

Meeting Date: 7/29/2010
 Meeting Time: 6 PM
 Meeting Address: 2353 LOMBARD ST SAN FRANCISCO CA
 Project Address: 2353 LOMBARD ST SAN FRANCISCO CA
 Property Owner Name: REALTY EQUITIES INC
 Project Sponsor/Representative: HOWARD SQUIRES

Please print your name below, state your address and/or affiliation with a neighborhood group, and provide your phone number. Providing your name below does not represent support or opposition to the project; it is for documentation purposes only.

NAME/ORGANIZATION	ADDRESS	PHONE #	EMAIL	SEND PLANS
1. Susanne Stolzenberg	2443 Greenwich			<input type="checkbox"/>
2. BERNARD BAUER	2443 GREENWICH		bb2250@yahoo.com	<input checked="" type="checkbox"/>
3. JOSEPH BREALL	1550 Bryant St		jmbreall@breall.com	<input checked="" type="checkbox"/>
4. TOM HARRISON		(415) 567-5887		<input type="checkbox"/>
5.				<input type="checkbox"/>
6.				<input type="checkbox"/>
7.				<input type="checkbox"/>
8.				<input type="checkbox"/>
9.				<input type="checkbox"/>
10.				<input type="checkbox"/>
11.				<input type="checkbox"/>
12.				<input type="checkbox"/>
13.				<input type="checkbox"/>
14.				<input type="checkbox"/>

Summary of discussion from the Pre-Application Meeting

Meeting Date: 7/22/10
Meeting Time: 6 PM
Meeting Address: 2353 LOMBARD
Project Address: 2353 LOMBARD
Property Owner Name: REALTY EQUITIES INC
Project Sponsor/Representative: HOWARD SQUIRES, PRESIDENT

Please summarize the questions/comments and your response from the Pre-Application meeting in the space below. Please state if/how the project has been modified in response to any concerns.

Question/Concern #1 by (name of concerned neighbor/neighborhood group): BERNARD BAUER ^{2443 GREENWICH}
CONCERNED ABOUT OVERALL HEIGHT OF ELEVATOR AND STAIR TOWER.

Project Sponsor Response: MR. BAUER WAS GIVEN ESTIMATED HEIGHT OF BUILDING NEXT DOOR TO PROJECT SITE SO HE COULD EVALUATE THE EFFECTS OF THE ELEVATOR AND STAIR TOWER ON HIS VIEW. WE WILL HAVE FOLLOW-UP DISCUSSIONS WITH MR. BAUER.

Question/Concern #2:
TOM HARRISON - CONCERNED ABOUT PRIVACY IN HIS YARD AS HIS PROPERTY ABUTS THE REAR OF THE PROJECT SITE

Project Sponsor Response: WE ARE REVIEWING CONSTRUCTION OF AN 8' WALL AT THE REAR OF THE PROPOSED PROJECT AND WILL CONTINUE TO ADDRESS MR. HARRISON'S CONCERNS.

Question/Concern #3: _____

Project Sponsor Response: _____

Question/Concern #4: _____

Affidavit of Conducting a Pre-Application Meeting, Sign-in Sheet and Issues/Responses submittal

I, HOWARD SQUIRES, do hereby declare as follows:
(print name)

1. I have conducted a Pre-Application Meeting for the proposed new construction or alteration prior to submitting any entitlement (Building Permit, Variance, Conditional Use, etc.) in accordance with Planning Commission Pre-Application Policy.
2. The meeting was conducted at 2353 LOMBARD (location/address)
on July 22, 2010 (date) from 6 PM - 7:45 PM (time).
3. I have included the mailing list, meeting initiation, sign-in sheet, issue/response summary, and reduced plans with the entitlement Application. I understand that I am responsible for the accuracy of this information and that erroneous information may lead to suspension or revocation of the permit.
4. I have prepared these materials in good faith and to the best of my ability.

I declare under penalty of perjury under the laws of the State of California that the foregoing is true and correct.

EXECUTED ON THIS DAY, July 29, 2010 IN SAN FRANCISCO

Signature

HOWARD SQUIRES, PRESIDENT
Name (type or print) REALTY EQUITIES, INC

PRESIDENT

Relationship to Project, e.g., Owner, Agent
(if Agent, give business name and profession)

2353 LOMBARD
Project Address