



SAN FRANCISCO PLANNING DEPARTMENT

MEMO

Disclaimer for Review of Plans

The San Francisco Planning Code requires that the plans of certain proposed projects be provided to members of the public prior to the City's approval action on the project. Accordingly, any images of plans featured on this website are provided for the primary purpose of facilitating public input prior to the City's action. The City and County of San Francisco does not own the copyright to these images. Please be aware that the unauthorized reproduction, distribution, or alteration of these images may result in a violation of Federal Copyright Law (17 U.S.C.A. Sections 101 et seq.) and that any party who seeks to reproduce or alter these images does so at his or her own risk.

Additionally, plans provided on this website are limited to site plans, elevations and/or section details (floor plans and structural details may not be included). These are DRAFT PLANS being provided for public review PRIOR to the City's approval action on the project. Final plans may differ from those that are currently available for review.

1650 Mission St.
Suite 400
San Francisco,
CA 94103-2479

Reception:
415.558.6378

Fax:
415.558.6409

Planning
Information:
415.558.6377



**SAN FRANCISCO
PLANNING DEPARTMENT**

1650 Mission Street, Suite 400 • San Francisco, CA 94103 • Fax (415) 558-6409

NOTICE OF PUBLIC HEARING

Hearing Date: **Wednesday, September 25, 2013**
 Time: **9:30 AM**
 Location: **City Hall, 1 Dr. Carlton B. Goodlett Place, Room 408**
 Case Type: **Variance(Exposure)**
 Hearing Body: **Zoning Administrator**

PROPERTY INFORMATION	APPLICATION INFORMATION
Project Address: 1410 Jefferson St	Case No.: 2012.1448V
Cross Street(s): Webster Street	Building Permit: 201304184834
Block / Lot No.: 0436C/002	Applicant/Agent: Elida Doldan-Schujman
Zoning District(s): RH-2 / 40-X	Telephone: 415.332.3438
Area Plan: N/A	E-Mail: elarchst@sbcglobal.net

PROJECT DESCRIPTION

The project includes the addition of a dwelling unit at the rear of the ground floor of a four-story, single-family house.

Section 140 of the Planning Code requires at least one room in each dwelling unit to face directly onto a public street, public alley, side yard at least 25 feet in width or Code compliant rear yard. The required rear yard for the subject property is approximately 29 feet. The proposed dwelling unit would face onto a non-compliant rear yard measuring approximately 15 feet in depth; therefore, a variance is required.

ADDITIONAL INFORMATION

FOR MORE INFORMATION, PLEASE CONTACT PLANNING DEPARTMENT STAFF:

Planner: **Kanishka Burns** Telephone: **415-575-9112** Mail: kanishka.burns@sfgov.org

ARCHITECTURAL PLANS: The site plan and elevations of the proposed project are available on the Planning Department's website at: <http://sf-planning.org/ftp/files/notice/2012.1448V.pdf>

中文詢問請電 : 558.6378

Para información en Español llamar al: 558.6378

GENERAL INFORMATION ABOUT PROCEDURES

VARIANCE HEARING INFORMATION

Under Planning Code Section 306.3, you, as a property owner or resident within 300 feet of this proposed project or interested party on record with the Planning Department, are being notified of this Variance Hearing. **You are not obligated to take any action. For more information regarding the proposed work, or to express concerns about the project, please contact the Applicant/Agent or Planner listed on this notice as soon as possible.** Additionally, you may wish to discuss the project with your neighbors and neighborhood association or improvement club, as they may already be aware of the project.

Persons who are unable to attend the public hearing may submit written comments regarding this application to the Zoning Administrator, Planning Department, 1650 Mission Street, Suite 400, San Francisco, CA 94103, by 5:00pm the day prior to the hearing. These comments will be made a part of the official public record, and will be brought to the attention of the person or persons conducting the public meeting or hearing

BUILDING PERMIT APPLICATION INFORMATION

Under Planning Code Section 311/312, the Building Permit Application for this proposal is also subject to a 30-day notification to occupants and owners within 150-feet of the subject property. **The mailing of such notification will be performed separately.**

BOARD OF APPEALS

An appeal of the approval (or denial) of a **variance application** by the Zoning Administrator may be made to the **Board of Appeals within 10 days** after the **Variance Decision Letter** is issued by the Zoning Administrator.

An appeal of the approval (or denial) of a **building permit application** by the Planning Department may be made to the **Board of Appeals within 15 days** after the **building permit** is issued (or denied) by the Director of the Department of Building Inspection.

Appeals must be submitted in person at the **Board's office at 1650 Mission Street, 3rd Floor, Room 304**. For further information about appeals to the Board of Appeals, including current fees, **contact the Board of Appeals at (415) 575-6880**.

ABOUT THIS NOTICE

The Planning Department is currently reviewing its processes and procedures for public notification as part of the Universal Planning Notification (UPN) Project. The format of this Public Hearing notice was developed through the UPN Project and is currently being utilized in a limited trial-run for notification of Variance Hearings.

If you have any comments or questions related to the UPN Project or the format of this notice, please visit our website at <http://upn.sfplanning.org> for more information.

中文詢問請電 : 558.6378

Para información en Español llamar al: 558.6378

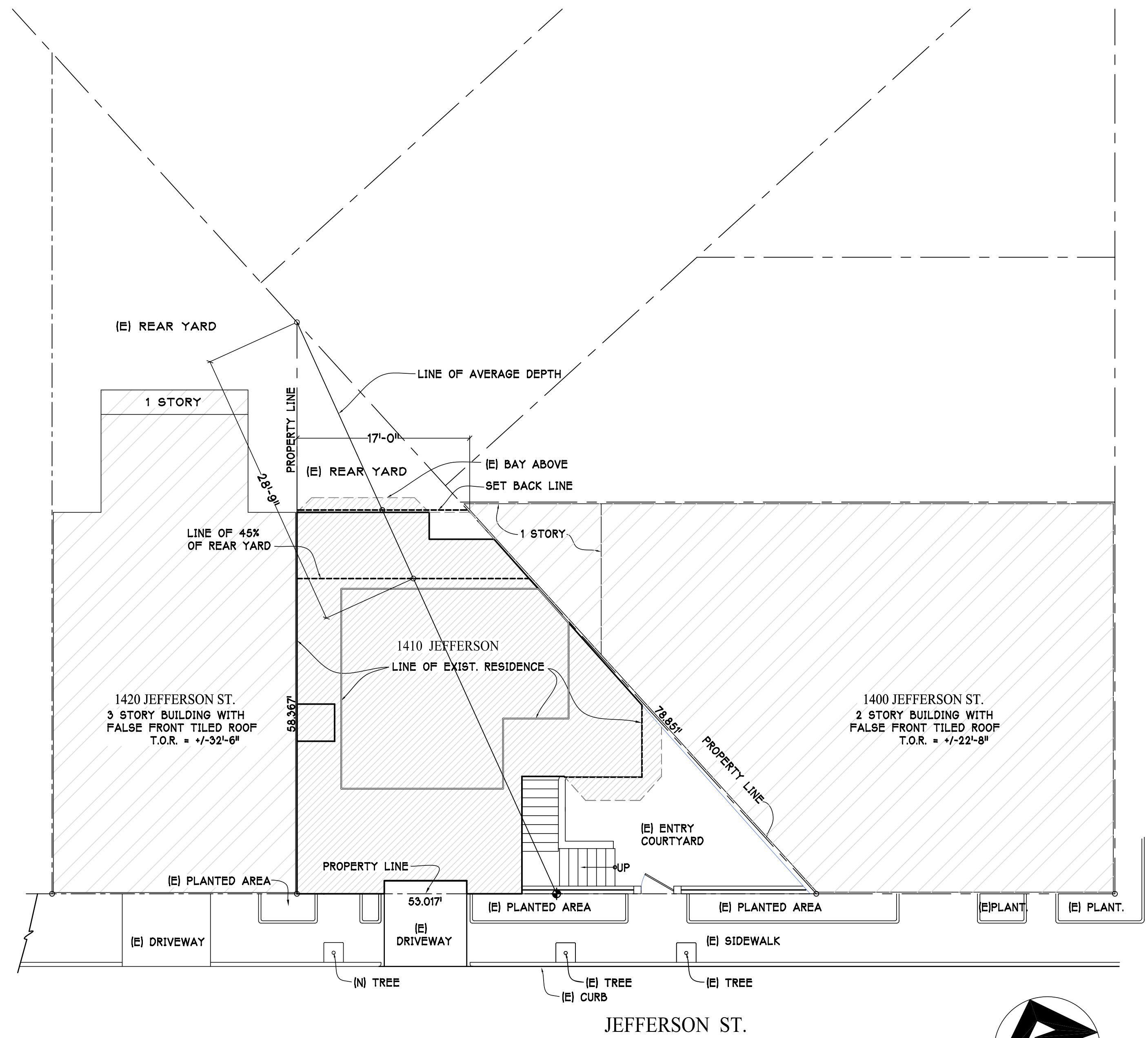

PROPOSED SITE PLAN

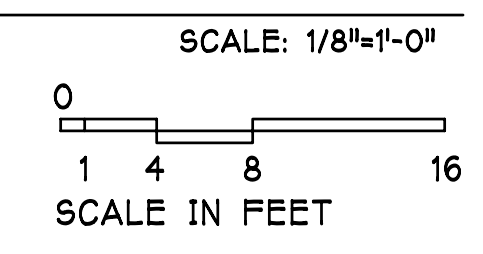
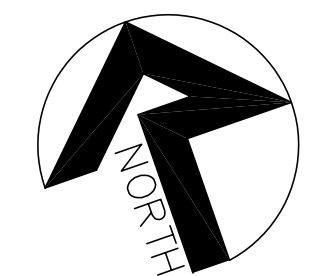

VICINITY MAP

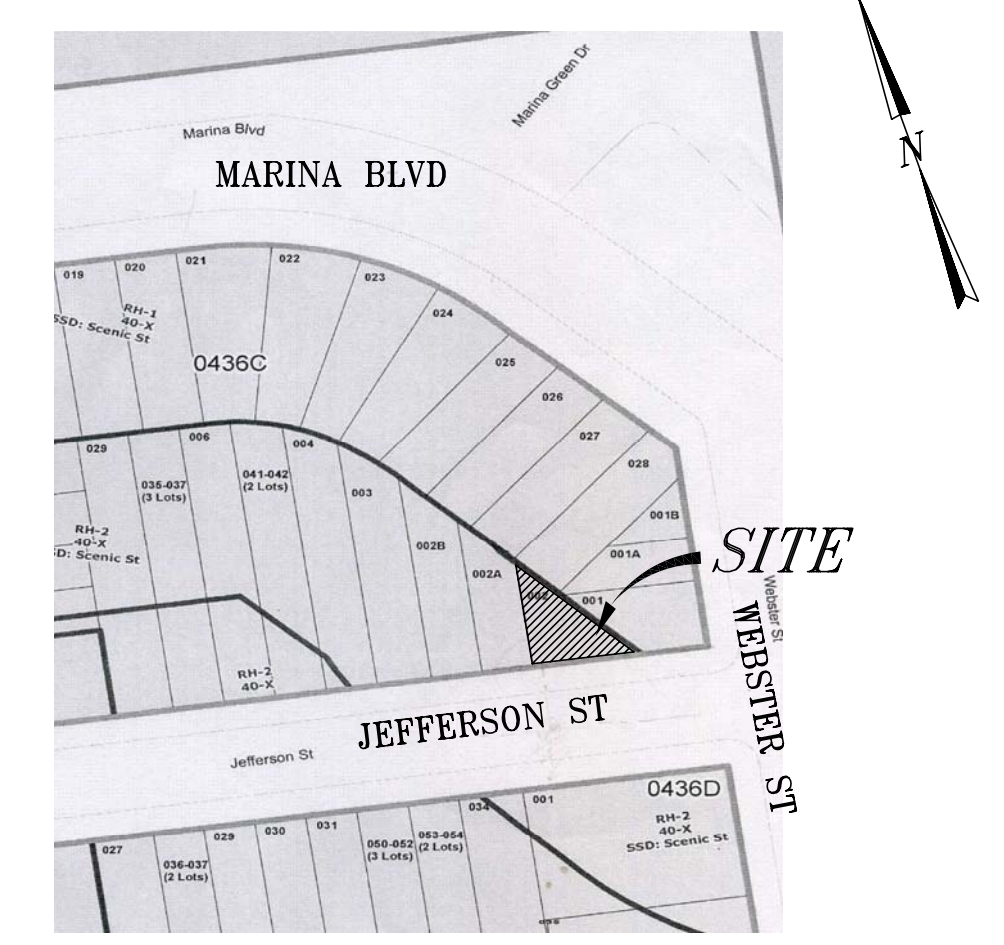

PROJECT DATA

SITE PLAN SUMMARY:

BLOCK: 0436C LOT: 002
 ZONE: RH-2
 REAR SETBACK: EXISTING (NO CHANGE)
 FRONT SETBACK: EXISTING (NO CHANGE)
 STORIES: (E) 4
 (N) 4

BUILDING SQ. FT.:

1) EXISTING RES. SQ. FT.:
 FIRST FLOOR = 998 sq. ft.
 SECOND FLOOR = 1,087 sq. ft.
 THIRD FLOOR = 934 sq. ft.
 FOURTH FLOOR = 389 sq. ft.
 TOTAL = 3,408 sq. ft.

2) PROPOSED RES. SQ. FT.:
 FIRST FLOOR = 998 sq. ft.
 SECOND FLOOR = 1,087 sq. ft.
 THIRD FLOOR = 1,045 sq. ft.
 FOURTH FLOOR = 413 sq. ft.
 TOTAL = 3,543 sq. ft.

USABLE OPEN SPACE: (PER S.F. PLANNING CODE SEC 135 MIN REQD IN RH-2 = 125 SQ. FT.)

1) SECOND UNIT = 185 SQ. FT. (REAR YARD)
 2) MAIN HOUSE = 193 SQ. FT. (ROOF TOP DECK)

OCCUPANCY: R-3 (NO CHANGE)
 OCCUPANCY: R-3 (NO CHANGE)
 NO. OF PARKING: (E) 1
 (N) 2

TYPE OF CONSTRUCTION: V-B
 HEIGHT LIMIT: 40'-0" / EXISTING = 41'-10"

SCOPE OF WORK:

HORIZONTAL AND VERTICAL ADDITION OF A SINGLE FAMILY DWELLING: 111 SF ON THIRD FLOOR AND 24 SF ON FOURTH FLOOR (BUILDING PERMIT APPLICATION)
 CONVERSION OF AN EXISTING FIRST FLOOR GUEST SUITE TO A LEGAL SECOND UNIT. (VARIANCE APPLICATION FOR CODE SECTION 140)

CODES:

ALL WORK TO COMPLY WITH THE FOLLOWING BUILDING CODES:

- 2010 CBC & S.F. AMENDMENTS
- 2010 CMC & S.F. AMENDMENTS
- 2010 CPC & S.F. AMENDMENTS
- 2010 CEC & S.F. AMENDMENTS
- 2010 CFC & S.F. AMENDMENTS
- CALIFORNIA ENERGY CODE
- S.F. HOUSING CODE

INDEX:

- A-1.1 SITE PLAN - PROJECT DATA
- A-2.1 FLOOR PLANS
- A-3.1 NOT INCLUDED
- A-4.1 EXTERIOR ELEVATIONS
- A-4.2 EXTERIOR ELEVATIONS
- L-1.1 HARDSCAPE PLAN / LANDSCAPE
- EX-2 EXISTING FLOOR PLANS

REVISIONS	BY
6-28-13	MD

ELIDA DOLDAN SCHUMAN AIA CID
 ARCHITECTURE STUDIO
 216 Sycamore Avenue
 San Francisco, CA 94102
 Tel. 415/281-3536, Fax. 415/281-0271
 E-mail: elarbst@sigobahn.net

HOUSE REMODEL FOR:
 GREGG CRAWFORD, KATHERINE CRAWFORD & JOHN F. WARD JR.,
 CO-TRUSTEES, THE WHITNEY D. CRAWFORD IRREVOCABLE TRUST OF 2011
 1410 JEFFERSON STREET, SAN FRANCISCO, CALIFORNIA

DATE	7-10-13
SCALE	AS NOTED
DRAWN	MJD
JOB	
SHEET	A-1.1
OF	SHEETS

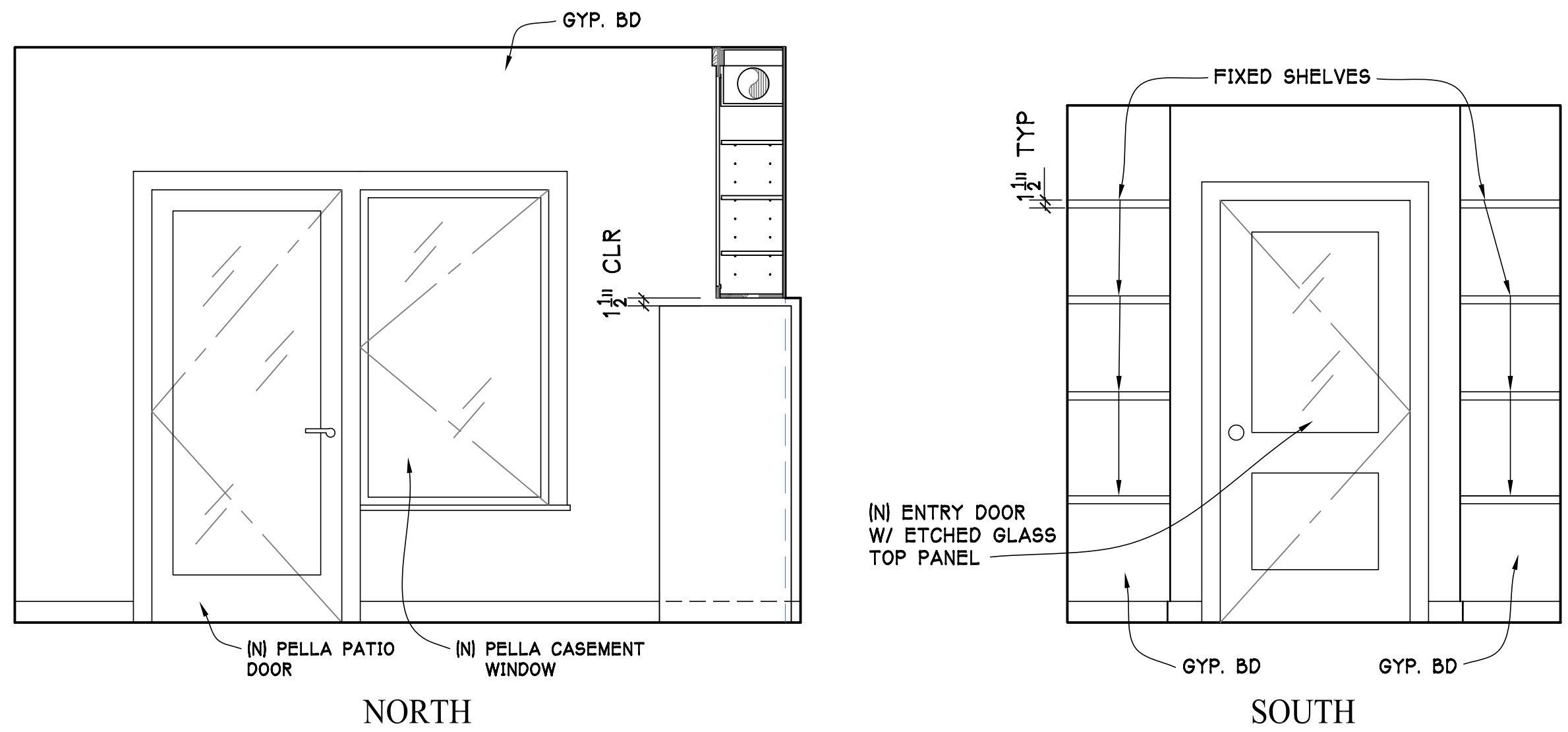

INTERIOR ELEVATIONS AT SECOND UNIT

SCALE: 1/2"=1'-0"

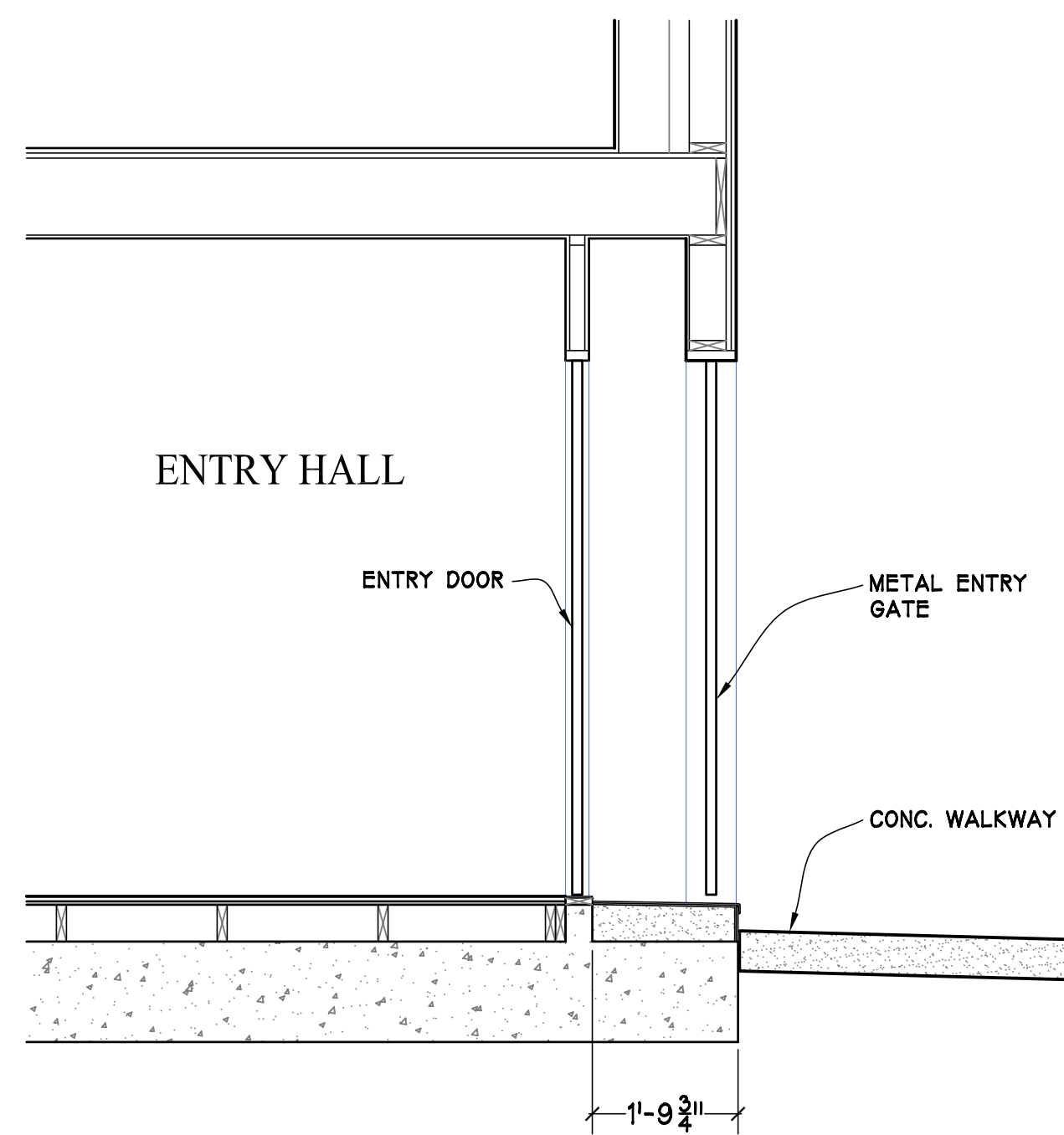

SECTION A THRU ENTRY HALL

SCALE: 1/2"=1'-0"

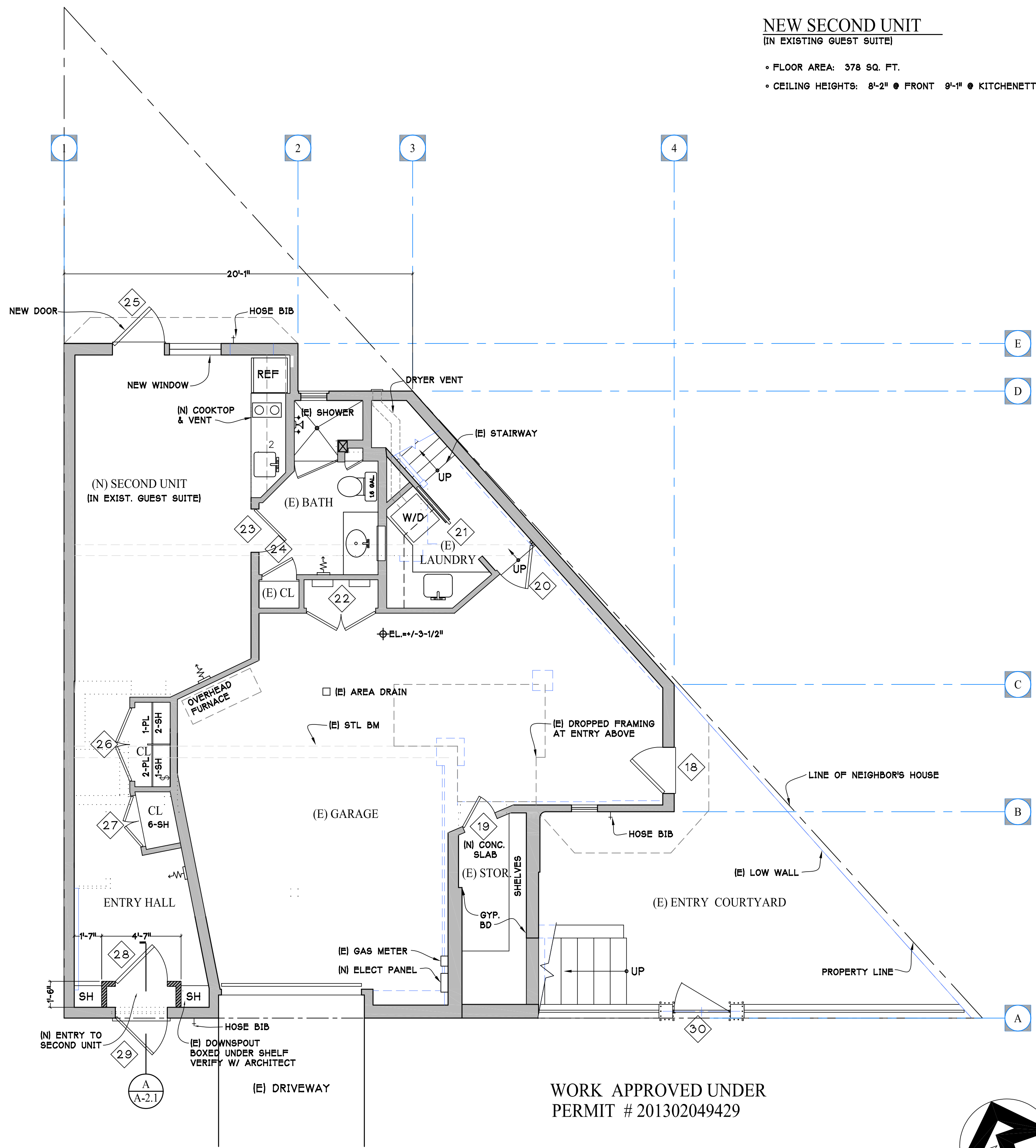

PROPOSED FIRST FLOOR PLAN

SCALE: 1/4"=1'-0"

- SYMBOLS LIST**
- EXISTING
 - NEW
 - DEMO
 - (N) NEW
 - CONTROL LINE
 - HEAT REGISTER

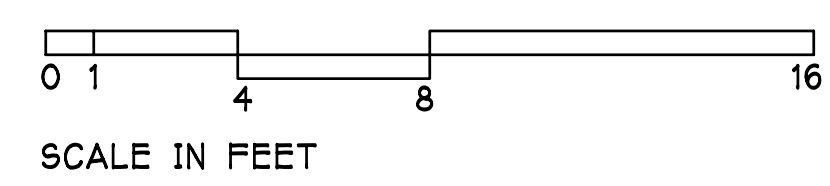

NEW SECOND UNIT
(IN EXISTING GUEST SUITE)

- FLOOR AREA: 378 SQ. FT.
- CEILING HEIGHTS: 8'-2" • FRONT 9'-0" • KITCHENETTE

REVISIONS	BY
6-28-13	MD

HOUSE REMODEL FOR:
GREGG CRAWFORD, KATHERINE CRAWFORD & JOHN F. WARD JR.,
 CO-TRUSTEES, THE WHITNEY D. CRAWFORD IRREVOCABLE TRUST OF 2011
 1410 JEFFERSON STREET, SAN FRANCISCO, CALIFORNIA

ELIDA DOLDAN SCRIMAN AIA CID
 ARCHITECTURE STUDIO
 216 Sycamore Avenue
 San Francisco, CA 94116
 Tel. 415/281-3536, Fax 415/281-0221
 E-mail: elidast@sigobal.net

DATE 7-10-13
 SCALE AS NOTED
 DRAWN MJD
 JOB
 SHEET
A-2.1
 OF SHEETS

ALL DRAWINGS AND WRITTEN MATERIAL APPEARING HEREIN CONSTITUTE THE ORIGINAL AND UNPUBLISHED WORK OF THE ARCHITECT, ELIDA DOLDAN SCRIMAN. THEY MAY NOT BE REPRODUCED, COPIED, USED, TRANSFORMED, OR DISTRIBUTED FOR ANY REASON WITHOUT THE EXPRESSED WRITTEN PERMISSION OF THE ARCHITECT.

REVISIONS	BY
6-28-13	MD

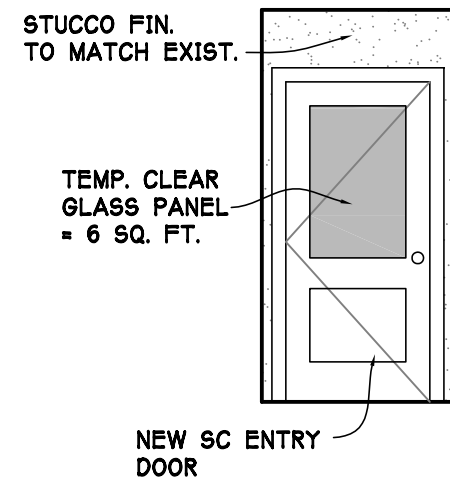

EXTERIOR ELEVATION A

SCALE: 1/4"=1'-0"

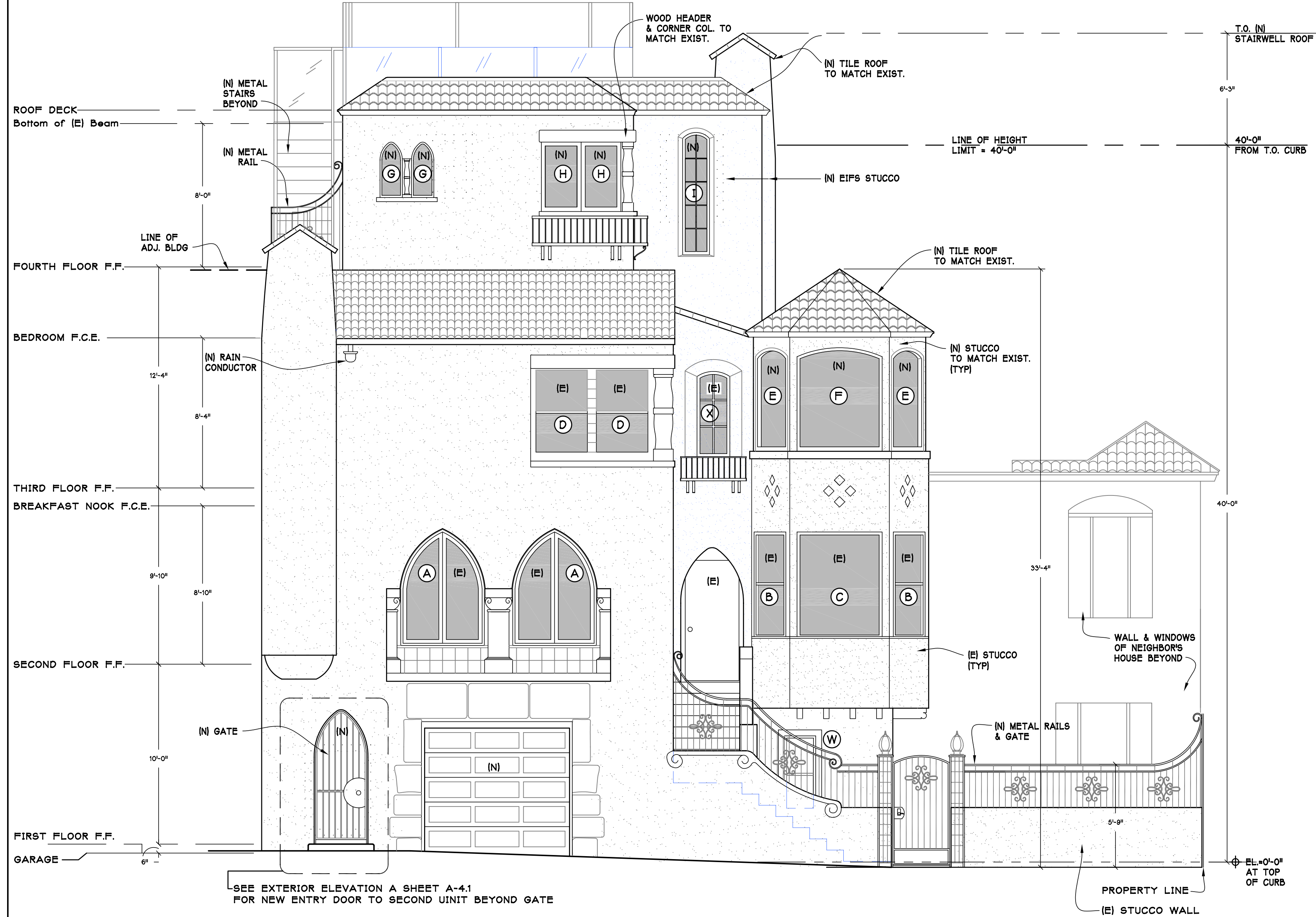

PROPOSED SOUTH EXTERIOR ELEVATION

SCALE: 1/4"=1'-0"

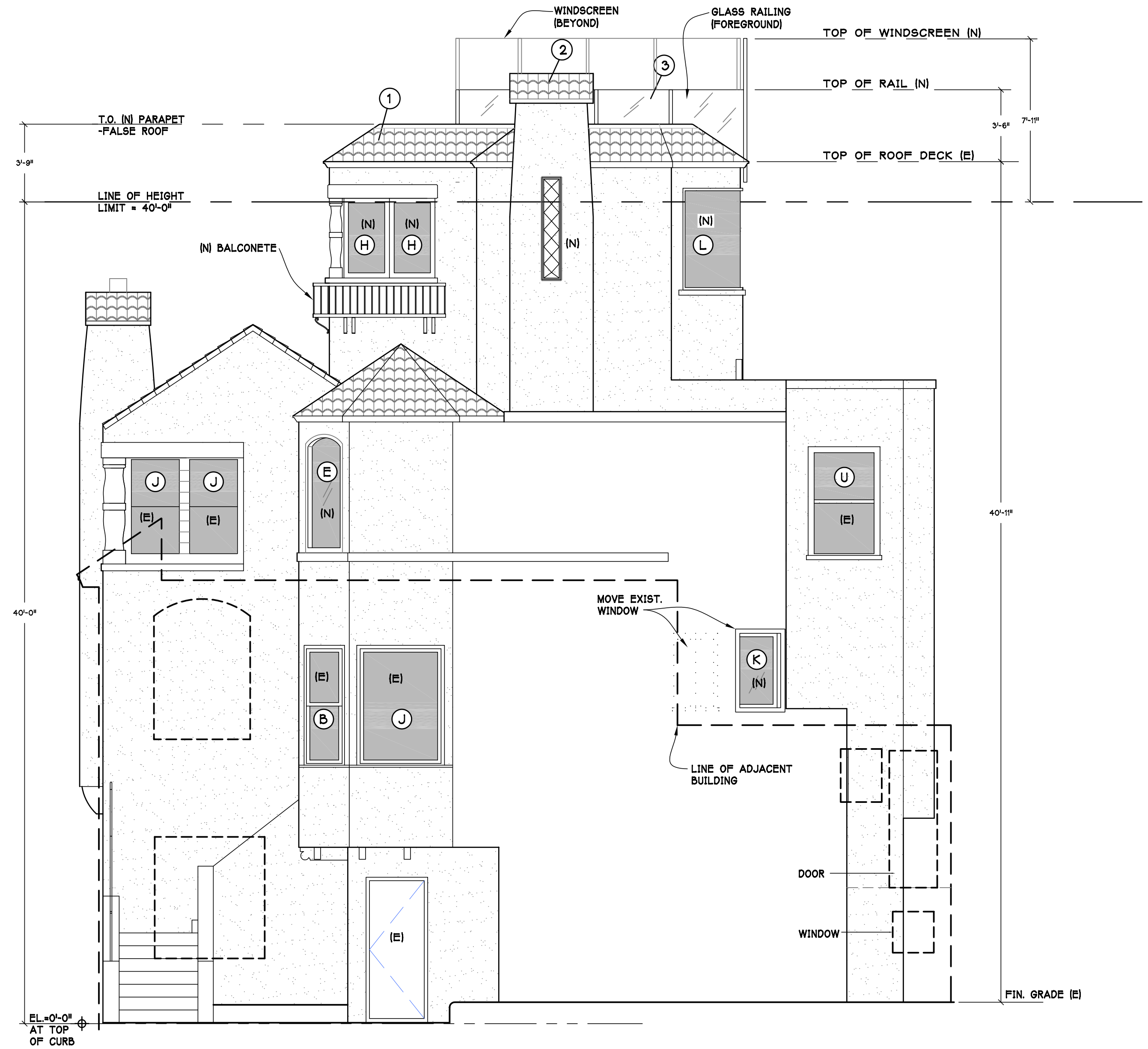

PROPOSED EAST EXTERIOR ELEVATION

SCALE: 1/4"=1'-0"

ELIDA DOLDAN SCHUMAN AIA CID
ARCHITECTURE STUDIO
215 Sycamore Avenue
San Francisco, CA 94102
Tel. 415/381-3536, Fax 415/381-0271
E-mail: elarbst@sigobahn.net

HOUSE REMODEL FOR:
GREGG CRAWFORD, KATHERINE CRAWFORD & JOHN F. WARDA JR.,
CO-TRUSTEES, THE WHITNEY D. CRAWFORD IRREVOCABLE TRUST OF 2011
1410 JEFFERSON STREET, SAN FRANCISCO, CALIFORNIA

DATE	7-10-13
SCALE	AS NOTED
DRAWN	MJD
JOB	
SHEET	A-4.1
OF SHEETS	

REVISIONS	BY
6-28-13	MD

ELIDA DOLDAN SCHRUMAN AIA CID
 ARCHITECTURE STUDIO
 216 Sacramento Avenue
 San Francisco, CA 94102
 Tel. 415/281-3536, Fax 415/281-0221
 E-mail: elarhist@siglobal.net

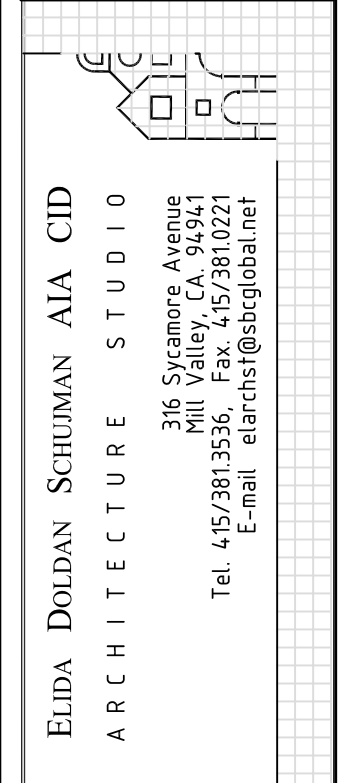

HOUSE REMODEL FOR:
GREGG CRAWFORD, KATHERINE CRAWFORD & JOHN F. WARD JR.,
CO-TRUSTEES, THE WHITNEY D. CRAWFORD IRREVOCABLE TRUST OF 2011
 1410 JEFFERSON STREET, SAN FRANCISCO, CALIFORNIA

DATE	7-10-13
SCALE	AS NOTED
DRAWN	MJD
JOB	
SHEET	A-4.2
OF	SHEETS

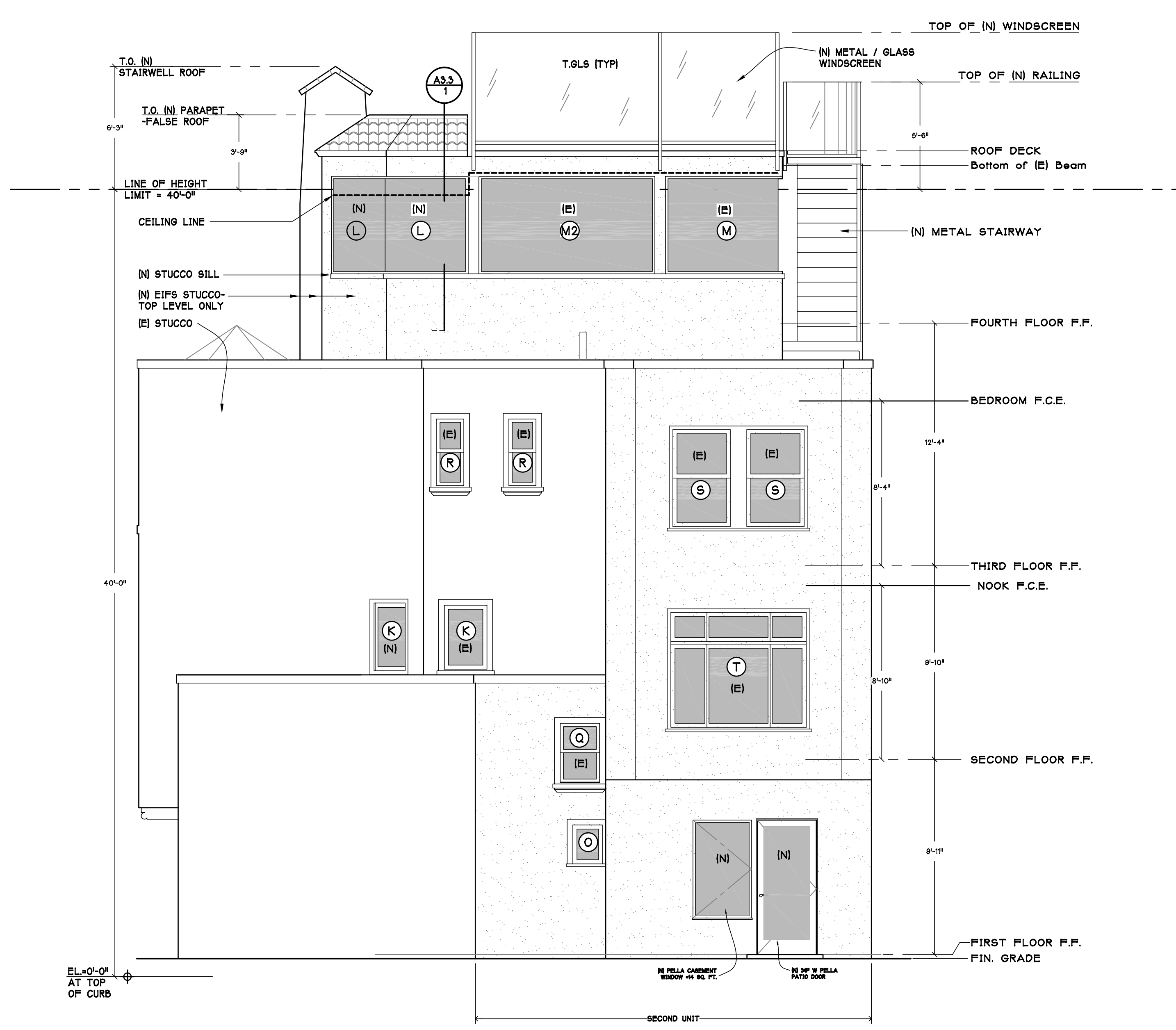

PROPOSED NORTH EXTERIOR ELEVATION

SCALE: 1/4"=1'-0"

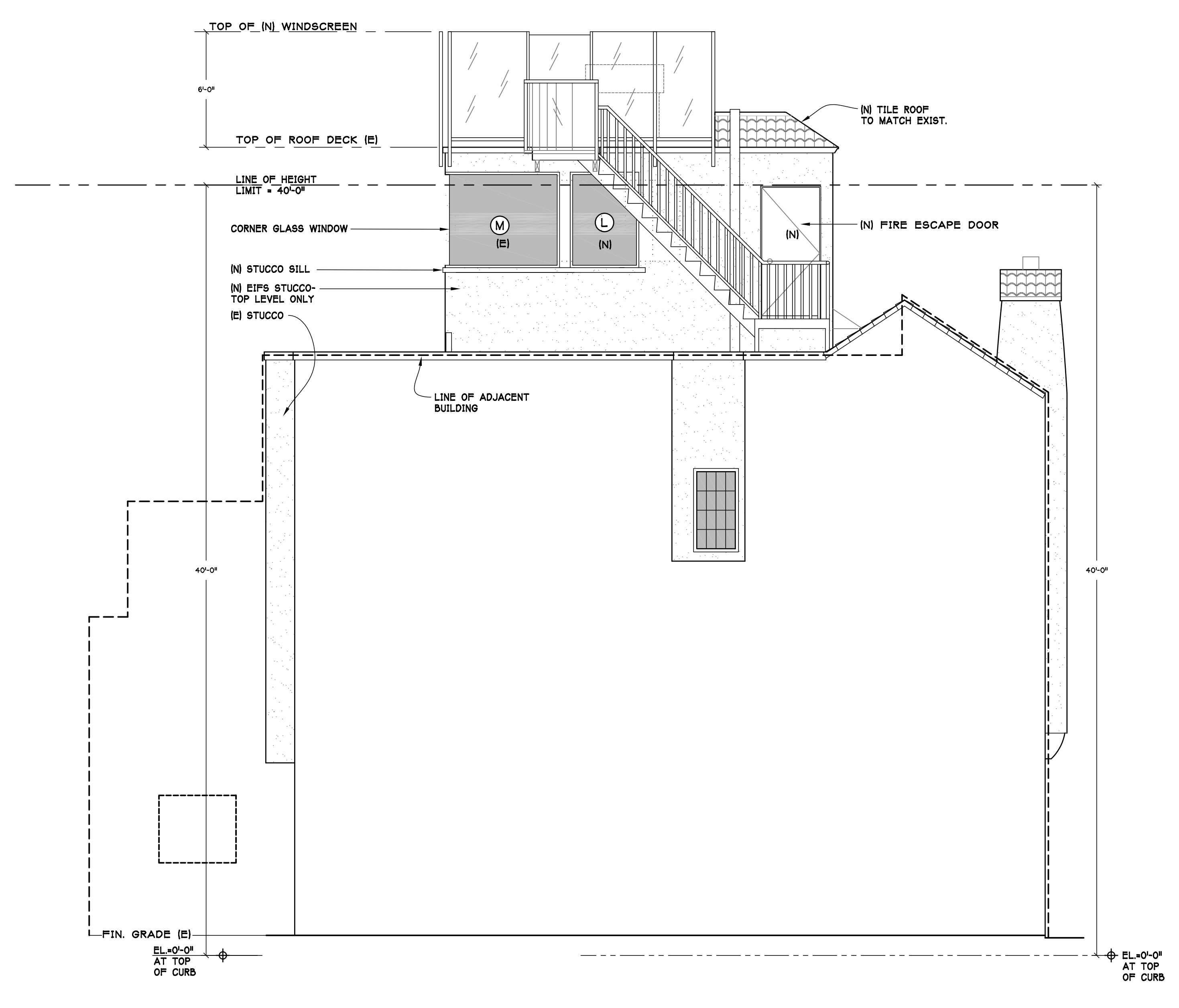

PROPOSED WEST EXTERIOR ELEVATION

SCALE: 1/4"=1'-0"

REVISIONS	BY
6-28-13	MD

ELIDA DOLDAN SCHUMAN AIA CID
 ARCHITECTURE STUDIO
 315 Sylvan Avenue
 Mill Valley, CA 94941
 Tel. 415/381-3536 Fax. 415/381-0271
 Email: edoldan@elidastudio.net

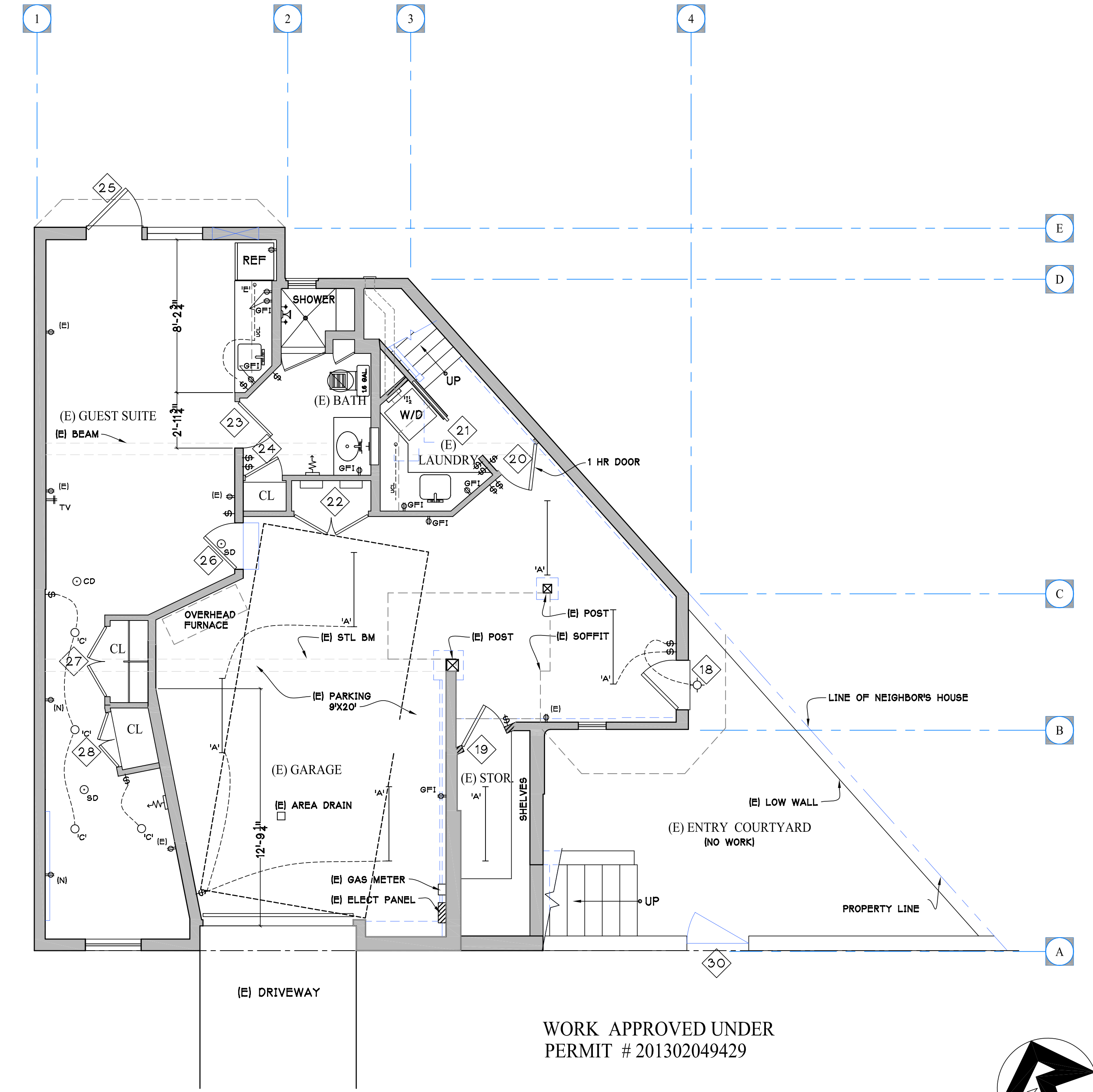

WORK APPROVED UNDER
 PERMIT # 201302049429

EXISTING FIRST LEVEL FLOOR PLAN

SCALE: 1/4"=1'-0"

SYMBOLS LIST

- EXISTING
- PERMIT #201302049429
- DEMO
- (N) NEW
- CONTROL LINE
- HEAT REGISTER

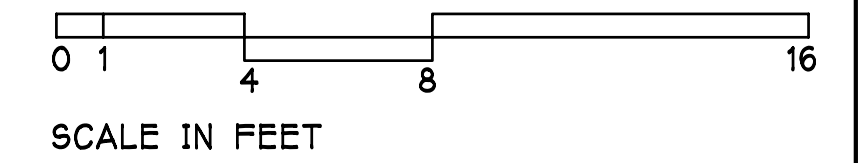

HOUSE REMODEL FOR:
 GREGG CRAWFORD, KATHERINE CRAWFORD & JOHN F. WARD JR.,
 CO-TRUSTEES, THE WHITNEY D. CRAWFORD IRREVOCABLE TRUST OF 2011
 1410 JEFFERSON STREET, SAN FRANCISCO, CALIFORNIA

DATE	7-10-13
SCALE	AS NOTED
DRAWN	MJD
JOB	
SHEET	EX-2
OF	SHEETS

REVISIONS	BY
6-28-13	MD

ELIDA DOLDAN SCHUMAN AIA CID
 ARCHITECTURE STUDIO
 315 Sycamore Avenue
 Mill Valley, CA 94041
 Tel. 415/381-3536 Fax. 415/381-0271
 Email: elid@elidastudio.com

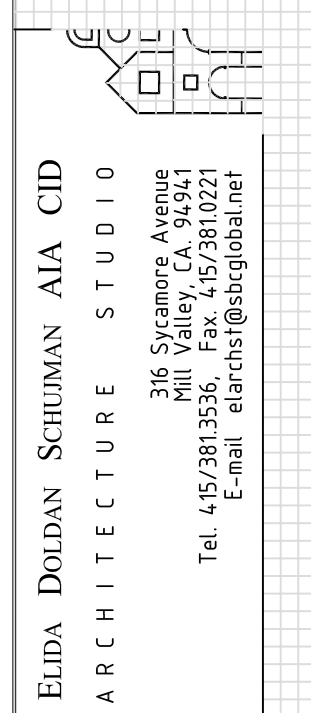

HOUSE REMODEL FOR:
 GREGG CRAWFORD, KATHERINE CRAWFORD & JOHN F. WARD JR.,
 CO-TRUSTEES, THE WHITNEY D. CRAWFORD IRREVOCABLE TRUST OF 2011
 1410 JEFFERSON STREET, SAN FRANCISCO, CALIFORNIA

DATE	7-10-13
SCALE	AS NOTED
DRAWN	MJD
JOB	
SHEET	L-1
OF	SHEETS

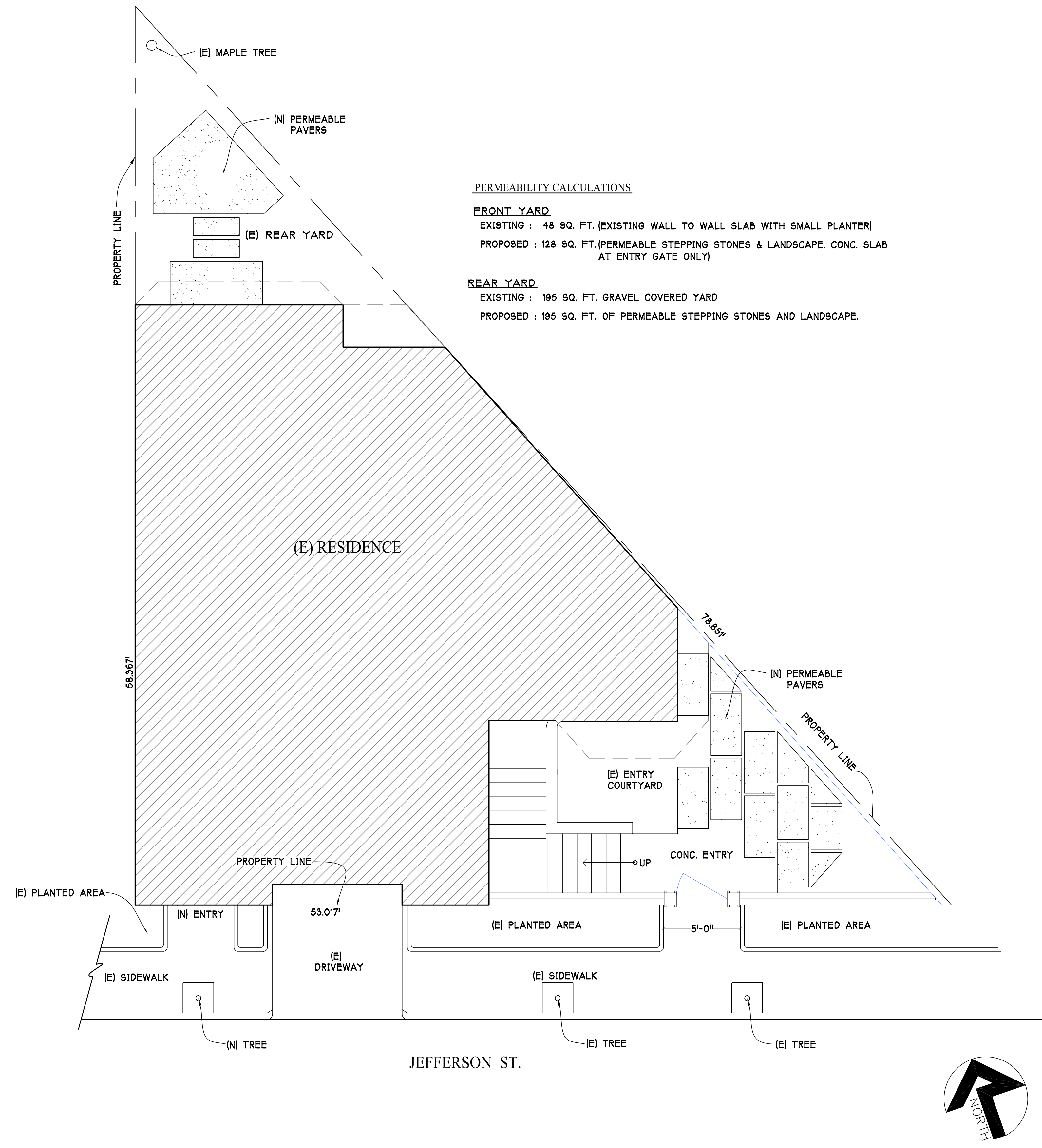

PERMEABILITY CALCULATIONS
FRONT YARD
 EXISTING : 48 SQ. FT. (EXISTING WALL TO WALL SLAB WITH SMALL PLANTER)
 PROPOSED : 128 SQ. FT. (PERMEABLE STEPPING STONES & LANDSCAPE. CONC. SLAB AT ENTRY GATE ONLY)
REAR YARD
 EXISTING : 195 SQ. FT. GRAVEL COVERED YARD
 PROPOSED : 195 SQ. FT. OF PERMEABLE STEPPING STONES AND LANDSCAPE.

PROPOSED LANDSCAPE PLAN

SCALE: 1/4"=1'-0"

ALL DRAWINGS AND WRITTEN MATERIAL APPEARING HEREIN CONSTITUTE THE ORIGINAL AND UNPUBLISHED WORK OF THE ARCHITECT, ELIDA DOLDAN SCHUMAN. THEY MAY NOT BE REPLICATED, USED, TRANSFORMED, OR DISTRIBUTED FOR ANY REASON WITHOUT THE EXPRESSED WRITTEN PERMISSION OF THE ARCHITECT.